

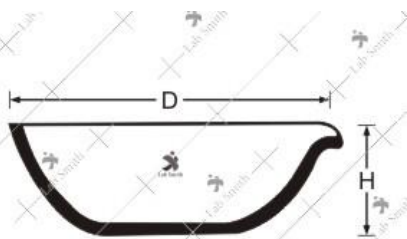

LAB QUARTZ WARE

1.1 Round Bottom Basins with Spout

- Made of Quartz



Ordering Information with Specifications:

Catalogue No.	Nominal Capacity (ml)	External Dimensions	
		Height H (mm)	Diameter D (mm)
T-600-100	Round Bottom Basins with Spout, 20	23	55
T-600-200	Round Bottom Basins with Spout, 45	27	75
T-600-300	Round Bottom Basins with Spout, 70	33	87
T-600-400	Round Bottom Basins with Spout, 85	36	94
T-600-500	Round Bottom Basins with Spout, 100	38	100
T-600-600	Round Bottom Basins with Spout, 200	47	113
T-600-700	Round Bottom Basins with Spout, 400	62	142



1.2 Deep Form Basin with Spout

- Made of Quartz

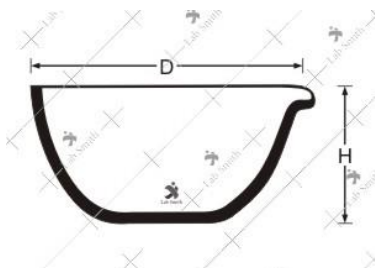

Ordering Information with Specifications:

Catalogue No.	Nominal Capacity (ml)	External Dimensions	
		Height H (mm)	Diameter D (mm)
T-600-800	Deep Form Basin with Spout, 10	18	40
T-600-900	Deep Form Basin with Spout, 15	25	50
T-601-000	Deep Form Basin with Spout, 45	30	60
T-601-100	Deep Form Basin with Spout, 90	45	80
T-601-200	Deep Form Basin with Spout, 170	55	100



1.3 Flat Form Basins with Spout

- Made of Quartz

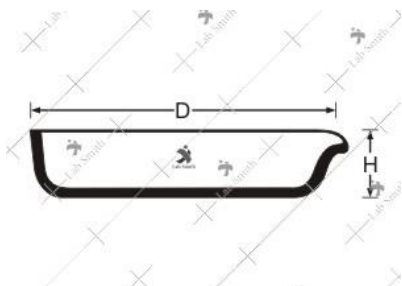

Ordering Information with Specifications:

Catalogue No.	Nominal Capacity (ml)	External Dimensions	
		Height H (mm)	Diameter D (mm)
T-601-300	Flat Form Basins with Spout, 20	15	69
T-601-400	Flat Form Basins with Spout, 25	15	79
T-601-500	Flat Form Basins with Spout, 75	20	101
T-601-600	Flat Form Basins with Spout, 125	23	131



1.4 Low Form Crucibles and Lids

- Made of Quartz

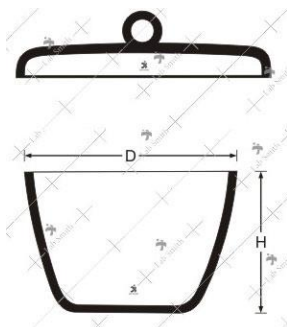

Ordering Information with Specifications:

Catalogue No.	Nominal Capacity (ml)	External Dimensions	
		Height H (mm)	Diameter D (mm)
T-601-700	Low Form Quartz Crucibles 5ml Without lid	19	29
L-601-700	Lid For Cat. No. T-601-700	-	-
T-601-800	Low Form Quartz Crucibles 10ml Without lid	19	38
L-601-800	Lid For Cat. No. T-601-800	-	-
T-601-900	Low Form Quartz Crucibles 15ml Without lid	25	41
L-601-900	Lid For Cat. No. T-601-900	-	-
T-602-000	Low Form Quartz Crucibles 25ml Without lid	28	47
L-602-000	Lid For Cat. No. T-602-000	-	-
T-602-100	Low Form Quartz Crucibles 50ml Without lid	37	57
L-602-100	Lid For Cat. No. T-602-100	-	-
T-602-200	Low Form Quartz Crucibles 80ml Without lid	45	67
L-602-200	Lid For Cat. No. T-602-200	-	-
T-602-300	Low Form Quartz Crucibles 150ml Without lid	51	82
L-602-300	Lid For Cat. No. T-602-300	-	-
T-602-400	Low Form Quartz Crucibles 100ml Without lid	48	72
L-602-400	Lid For Cat. No. T-602-400	-	-
T-602-500	Low Form Quartz Crucibles 125ml Without lid	-	-
L-602-500	Lid For Cat. No. T-602-500	-	-
T-602-600	Low Form Quartz Crucibles 250ml Without lid	-	-
L-602-600	Lid For Cat. No. T-602-600	-	-



1.5 Tall Form Crucibles & Lids

- Made of Quartz



Ordering Information with Specifications:

Catalogue No.	Nominal Capacity (ml)	External Dimensions	
		Height H (mm)	Diameter D (mm)
T-602-700	Tall Form Quartz Crucibles 10ml Without lid	32	27
L-602-700	Lid For Cat. No. T-602-700	-	-
T-602-800	Tall Form Quartz Crucibles 20ml Without lid	38	35
L-602-800	Lid For Cat. No. T-602-800	-	-
T-602-900	Tall Form Quartz Crucibles 30ml Without lid	39	43
L-602-900	Lid For Cat. No. T-602-900	-	-
T-603-000	Tall Form Quartz Crucibles 50ml Without lid	51	51
L-603-000	Lid For Cat. No. T-603-000	-	-
T-603-100	Tall Form Quartz Crucibles 200ml Without lid	81	73
L-603-100	Lid For Cat. No. T-603-100	-	-



1.6 Broad Base Crucibles

- Made of Quartz

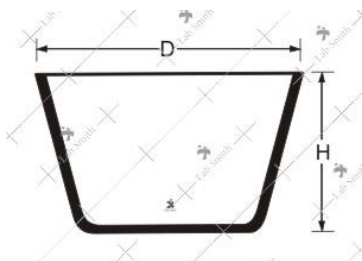

Ordering Information with Specifications:

Catalogue No.	External Dimensions		
	Nominal Capacity (ml)	Height H (mm)	Diameter D (mm)
T-603-200	Broad Base Crucibles, 15	24	41
T-603-300	Broad Base Crucibles, 25	27	48
T-603-400	Broad Base Crucibles, 40	37	57



1.7 Boats Combustion with Handle

- Made of Quartz

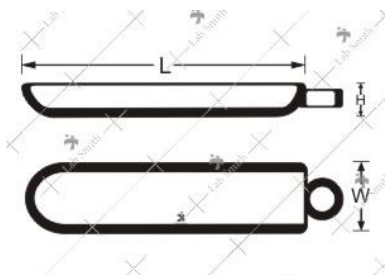

Ordering Information with Specifications:

Catalogue No.	External Dimensions		
	Length L (mm)	Width W (mm)	Height H (mm)
T-603-500	Boats Combustion with Handle, 49	15	9
T-603-600	Boats Combustion with Handle, 77	12	10
T-603-700	Boats Combustion with Handle, 77	17	11
T-603-800	Boats Combustion with Handle, 77	20	12
T-603-900	Boats Combustion with Handle, 103	20	12



1.8 Moisture & Ash Determination Circular Capsule with Ground Lid (B.S 705)

- Made of Quartz

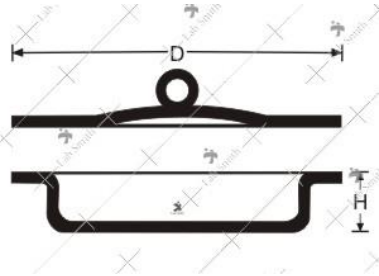

Ordering Information with Specifications:

Catalogue No.	External Dimensions	
	Height H (mm)	Diameter D (mm)
T-604-000	11	38
T-604-100	12	54
T-604-200	12	75

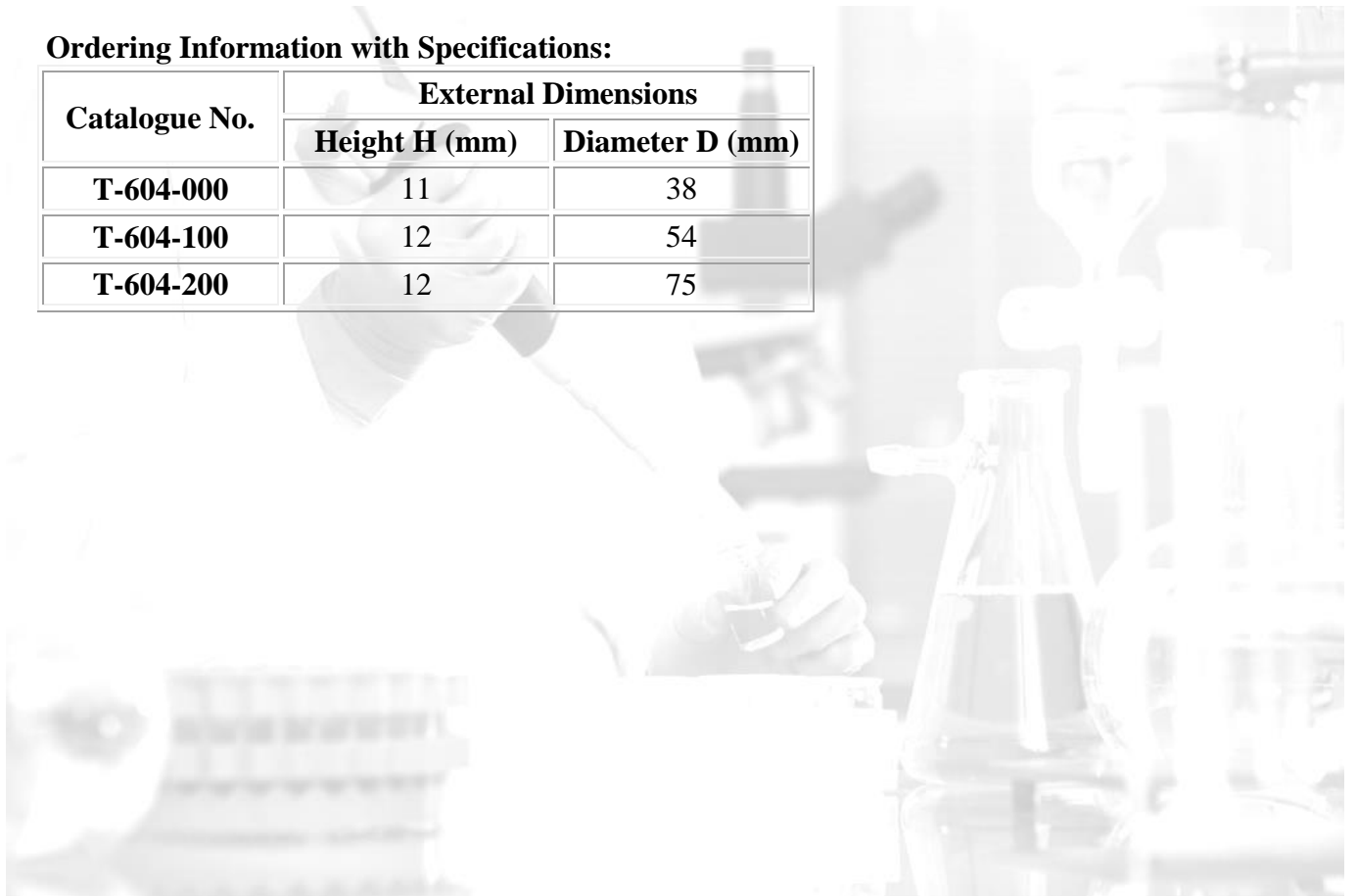



1.9 Volatile Matter Determination Coking Crucible & Lid B.S. 1016 (Part 1)

- Made of Quartz

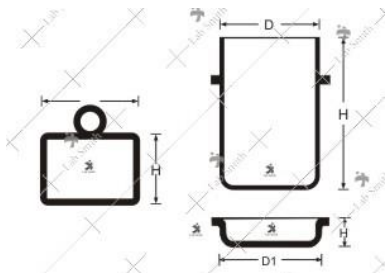

Ordering Information with Specifications:

Catalogue No.	Description	External Dimensions	
		Width W (mm)	Height H (mm)
T-604-300	Crucible with projection, Without Lid	38	25
T-604-400	Crucible without projection, Without Lid	38	25
T-604-500	Lids Use for T-604-300 & T-604-400	3-4.75	D1-21 to suit the crucible
T-604-600	Plunger Use for T-604-300 & T-604-400	12.5	to suit the crucible



1.10 Muffle Trays

- Made of Quartz

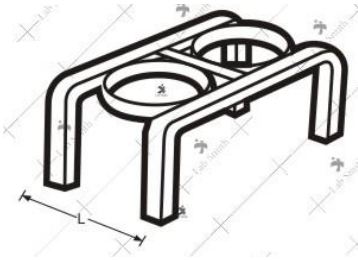

Ordering Information with Specifications:

Catalogue No.	Nominal Length L (mm)	No. of holes
T-604-700	Muffle Trays 39 mm	2
T-604-800	Muffle Trays 76 mm	4



1.11 Capsule Circular

- Made of Quartz

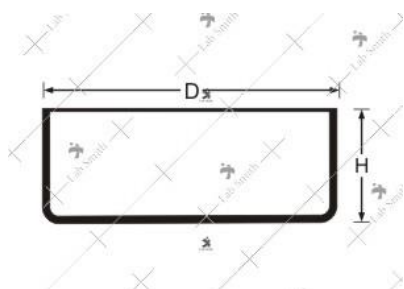

Ordering Information with Specifications:

Catalogue No.	Nominal Capacity (ml)	External Dimensions	
		Height H (mm)	Diameter D (mm)
T-604-900	Capsule Circular 10 ml	15	40
T-605-000	Capsule Circular 20 ml	15	48
T-605-100	Capsule Circular 25 ml	15	54
T-605-200	Capsule Circular 30 ml	15	62
T-605-300	Capsule Circular 35 ml	15	69
T-605-400	Capsule Circular 50 ml	18	78
T-605-500	Capsule Circular 45 ml	28	56
T-605-600	Capsule Circular 50 ml	28	62
T-605-700	Capsule Circular 80 ml	28	75
T-605-800	Capsule Circular 100 ml	28	87



1.12 Tobacco Ash Capsules

- Made of Quartz



Ordering Information with Specifications:

Catalogue No.	Nominal Capacity (ml)	External Dimensions		
		Height H (mm)	Width W (mm)	Length L (mm)
T-605-900	Tobacco Ash Capsules 90 ml	28	56	78

1.13 Rectangular Capsules

- Made of Quartz

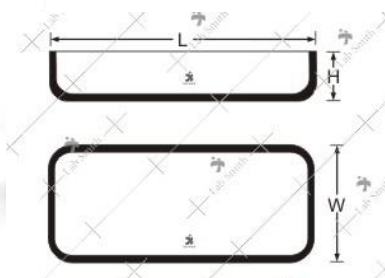

Ordering Information with Specifications:

Catalogue No.	Nominal Capacity (ml)	External Dimensions		
		Length L (mm)	Width W (mm)	Height H (mm)
T-606-000	Rectangular Capsules, 10	60	28	12
T-606-100	Rectangular Capsules, 20	68	39	12
T-606-200	Rectangular Capsules, 25	52	42	18



1.14 Gooch Crucible, Translucent

- Made of Quartz

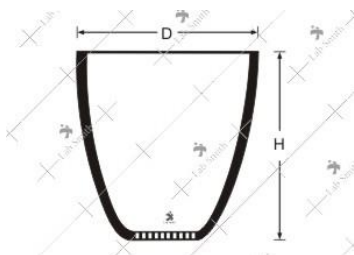

Ordering Information with Specifications:

Catalogue No.	Height H (mm)	Diameter D (mm)
T-606-300	Gooch Crucible, Translucent, 52	60

1.15 Triangle on Nichrome Wire

- Made of Quartz

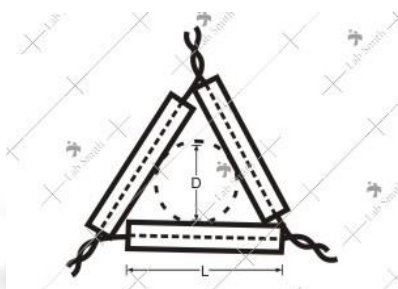

Ordering Information with Specifications:

Catalogue No.	Nominal Length of side L (mm)	Nominal Diameter of inscribed circle D (mm)
T-606-400	Triangle on Nichrome Wire 38 mm	20 mm
T-606-500	Triangle on Nichrome Wire 44 mm	24 mm
T-606-600	Triangle on Nichrome Wire 50 mm	28 mm
T-606-700	Triangle on Nichrome Wire 58 mm	32 mm
T-606-800	Triangle on Nichrome Wire 63 mm	35 mm
T-606-900	Triangle on Nichrome Wire 69 mm	38 mm
T-607-000	Triangle on Nichrome Wire 76 mm	43 mm



1.16 Crucible Swelling Number (B.S 1016 part I) Transparent

- Made of Quartz

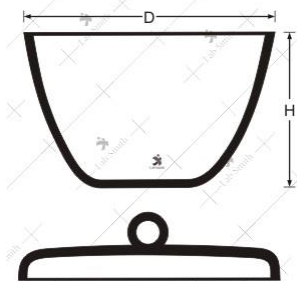

Ordering Information with Specifications:

Catalogue No.	Nominal Capacity	External Dimensions	
		Height H (mm)	Diameter D (mm)
T-607-100	Quartz Crucibles 17ml Without lid	26	41
T-607-100	Lid For Cat. No. T-607-100	-	-

1.17 Retort Tubes – Gray king Apparatus

- Made of Quartz

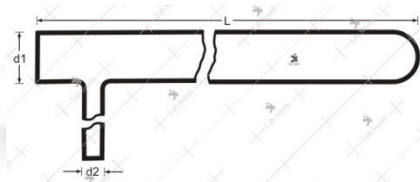

Ordering Information with Specifications:

Catalogue No.	Suitable for	Bore main tube D1 (mm)	Bore side tube D2 (mm)	Overall length L (mm)
T-607-400	Low temp. assay	21	8	300
T-607-500	High temp. assay	20	8	394



1.18 Tubes For Carbon Estimation Transparent

- Made of Quartz

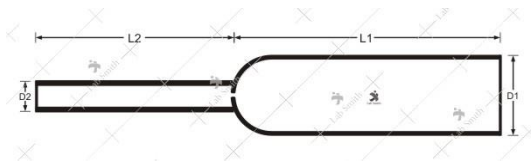

Ordering Information with Specifications:

Catalogue No.	Nominal Dimensions			
	Length L1 (mm)	Length L2 (mm)	Diameter D1 (mm)	Diameter D2 (mm)
T-607-600	128	108	35.5	13

1.19 Tubes For Sulphur Estimation Transparent

- Made of Quartz

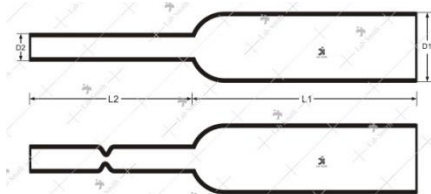

Ordering Information with Specifications:

Catalogue No.	Nominal Dimensions			
	Length L1 (mm)	Length L2 (mm)	Diameter D1 (mm)	Diameter D2 (mm)
T-607-700	128	108	35.5	13
T-607-800	128	108	35.5	13



1.20 Carbon & Sulphur Combustion Tube- Type A Transparent Leco Type CS 244

- Made of Quartz



Ordering Information:

Catalogue No.

T-607-900

1.21 Carbon & Sulphur Combustion Tube- Type B Transparent Leco Type CS 044

- Made of Quartz



Ordering Information:

Catalogue No.

T-608-000



1.22 Low form Beakers with spout, Transparent

- Made of Quartz



Ordering Information with Specifications:

Catalogue No.	Nominal Capacity (ml)	External Dimensions	
		Height H (mm)	Diameter D (mm)
T-608-100	Low form Beakers with spout, 50	55	44
T-608-200	Low form Beakers with spout, 100	70	52
T-608-300	Low form Beakers with spout, 150	82	59
T-608-400	Low form Beakers with spout, 200	88	68
T-608-500	Low form Beakers with spout, 250	100	81
T-608-600	Low form Beakers with spout, 400	108	82
T-608-700	Low form Beakers with spout, 500	117	90
T-608-800	Low form Beakers with spout, 600	127	100
T-608-900	Low form Beakers with spout, 1000	142	104



1.23 Tall form beakers with spout, transparent

- Made of Quartz

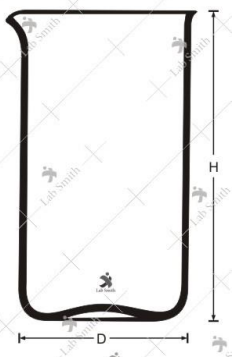

Ordering Information with Specifications:

Catalogue No.	Nominal Capacity (ml)	External Dimensions	
		Height H (mm)	Diameter D (mm)
T-609-000	Tall form beakers with spout, 25	54	31
T-609-100	Tall form beakers with spout, 50	70	42
T-609-200	Tall form beakers with spout, 100	80	49
T-609-300	Tall form beakers with spout, 150	87	56
T-609-400	Tall form beakers with spout, 250	106	64
T-609-500	Tall form beakers with spout, 400	120	73
T-609-600	Tall form beakers with spout, 500	130	78
T-609-700	Tall form beakers with spout, 600	140	85
T-609-800	Tall form beakers with spout, 1000	175	98



1.24 Flask Narrow Neck Transparent

- Made of Quartz

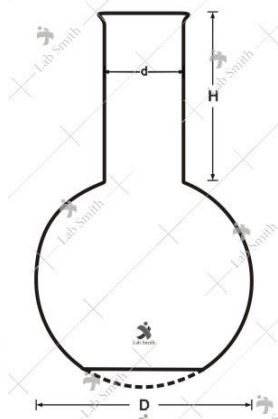

Ordering Information with Specifications:

Catalogue No.	Nominal Capacity (ml)	External Dimensions		
		Height H (mm)	Bulb D (mm)	Neck Dia. D (mm)
T-609-900	Flask Narrow Neck Transparent, 25	69	41	20
T-610-000	Flask Narrow Neck Transparent, 50	75	50	20
T-610-100	Flask Narrow Neck Transparent, 100	80	65	20
T-610-200	Flask Narrow Neck Transparent, 150	86	74	20
T-610-300	Flask Narrow Neck Transparent, 250	85	85	30
T-610-400	Flask Narrow Neck Transparent, 500	87	103	30
T-610-500	Flask Narrow Neck Transparent, 1000	130	132	30



1.25 Flask Wide Neck Transparent

- Made of Quartz

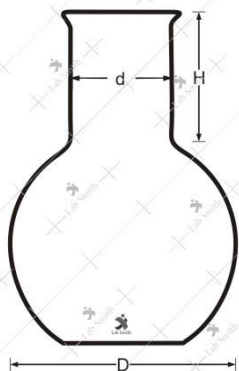

Ordering Information with Specifications:

Catalogue No.	Nominal Capacity (ml)	External Dimensions		
		Neck Height H (mm)	Bulb Dia. D (mm)	Neck Dia. d (mm)
T-610-600	Flask Wide Neck Transparent, 100	40	65	25
T-610-700	Flask Wide Neck Transparent, 250	48	85	35
T-610-800	Flask Wide Neck Transparent, 500	60	103	45



1.26 Flasks with Socket, Transparent

- Made of Quartz

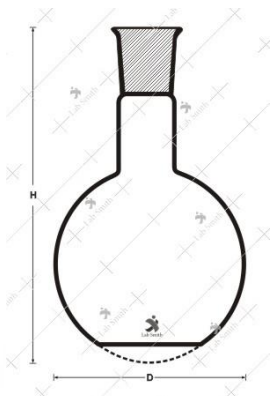

Ordering Information with Specifications:

Catalogue No.	Nominal Capacity (ml)	External Dimensions		
		Bulb Dia. D (mm)	Height H (mm)	Socket size
T-610-900	Flasks with Socket, Transparent, 5	25	50	10/19
T-611-000	Flasks with Socket, Transparent, 5	25	65	14/23
T-611-100	Flasks with Socket, Transparent, 10	30	65	10/19
T-611-200	Flasks with Socket, Transparent, 10	30	70	14/23
T-611-300	Flasks with Socket, Transparent, 25	40	75	14/23
T-611-400	Flasks with Socket, Transparent, 25	40	80	19/26
T-611-500	Flasks with Socket, Transparent, 50	50	90	14/23
T-611-600	Flasks with Socket, Transparent, 50	50	90	19/26
T-611-700	Flasks with Socket, Transparent, 100	65	105	14/23
T-611-800	Flasks with Socket, Transparent, 100	65	110	19/26
T-611-900	Flasks with Socket, Transparent, 150	75	115	19/26
T-612-000	Flasks with Socket, Transparent, 150	75	115	24/29
T-612-100	Flasks with Socket, Transparent, 250	85	130	24/29
T-612-200	Flasks with Socket, Transparent, 250	85	140	34/35
T-612-300	Flasks with Socket, Transparent, 500	105	150	24/29
T-612-400	Flasks with Socket, Transparent, 500	105	155	29/32
T-612-500	Flasks with Socket, Transparent, 500	105	165	34/35
T-612-600	Flasks with Socket, Transparent, 1000	132	180	24/29
T-612-700	Flasks with Socket, Transparent, 1000	132	185	29/32
T-612-800	Flasks with Socket, Transparent, 1000	132	195	34/35



1.27 Pear Shaped Flasks with Socket, Transparent

- Made of Quartz



Ordering Information with Specifications:

Catalogue No.	Nominal Capacity (ml)	External Dimensions	
		Height H (mm)	Socket Size
T-612-900	Pear Shaped Flasks with Socket, Transparent, 10	75	14/23
T-613-000	Pear Shaped Flasks with Socket, Transparent, 25	90	14/23
T-613-100	Pear Shaped Flasks with Socket, Transparent, 50	110	14/23
T-613-200	Pear Shaped Flasks with Socket, Transparent, 100	125	14/23



1.28 Flasks- KJELDAHL, Transparent

- Made of Quartz

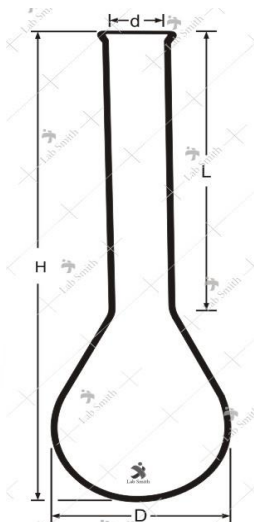

Ordering Information with Specifications:

Catalogue No.	Nominal Capacity (ml)	External Dimensions			
		Overall Height H (mm)	Bulb Diameter D (mm)	Neck Length L (mm)	Neck Dia. d (mm)
T-613-300	50	171	41	130	20
T-613-400	100	199	56	130	20
T-613-500	250	250	70	180	25
T-613-600	300	289	80	190	27
T-613-700	500	308	96	190	30
T-613-800	650	318	104	190	30
T-613-900	750	323	108	190	33
T-614-000	800	326	110	190	35
T-614-100	1000	355	125	190	35



1.29 Distilling Flasks, Transparent

- Made of Quartz

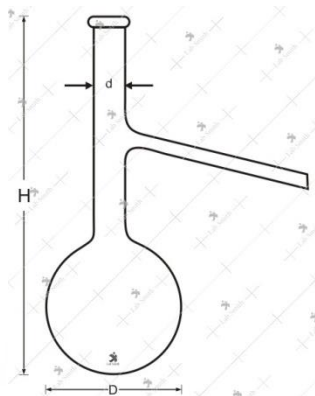

Ordering Information with Specifications:

Catalogue No.	Nominal Capacity (ml)	External Dimensions		
		Bulb Diameter D (mm)	Neck Dia. d (mm)	Overall Height H (mm)
T-614-200	25	40	19	110
T-614-300	50	52	19	122
T-614-400	100	65	19	155
T-614-500	125	69	19	163
T-614-600	150	74	22	170
T-614-700	200	79	24	181
T-614-800	250	86	24	192
T-614-900	500	102	26	247
T-615-000	750	124	26	284
T-615-100	1000	136	28	301



1.30 Conical Flasks (Erlenmeyer), Transparent

- Made of Quartz

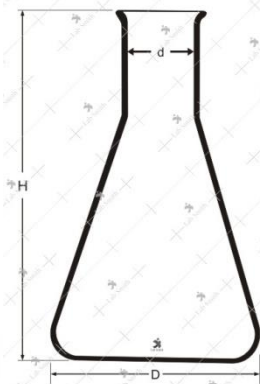

Ordering Information with Specifications:

Catalogue No.	Nominal Capacity (ml)	External Dimensions		
		Dia. At Base D (mm)	Overall Height H (mm)	Neck Dia. d (mm)
T-615-200	5	25	40	18
T-615-300	10	32	48	18
T-615-400	25	42	70	22
T-615-500	50	50	85	22
T-615-600	100	65	105	22
T-615-700	150	75	120	22
T-615-800	250	85	140	34
T-615-900	300	88	150	34
T-616-000	500	105	175	34
T-616-100	1000	130	220	42



1.31 Conical Flasks with Socket, Transparent

- Made of Quartz

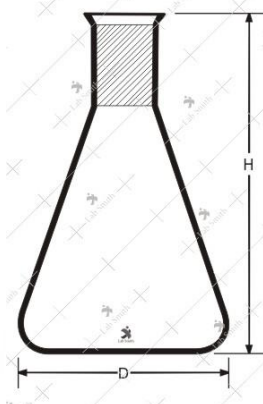

Ordering Information with Specifications:

Catalogue No.	Nominal Capacity (ml)	External Dimensions		
		Dia. at Base d (mm)	Overall Height H (mm)	Socket size
T-616-200	5	25	50	10/19
T-616-300	5	25	55	14/23
T-616-400	10	32	60	10/19
T-616-500	10	32	60	14/23
T-616-600	25	42	70	14/23
T-616-700	25	42	85	19/26
T-616-800	50	50	90	14/23
T-616-900	50	50	105	19/26
T-617-000	100	65	110	24/29
T-617-100	100	65	115	29/32
T-617-200	150	75	115	24/29
T-617-300	150	75	125	29/32
T-617-400	250	85	125	24/29
T-617-500	250	85	165	29/32
T-617-600	500	105	165	24/29
T-617-700	500	105	210	29/32
T-617-800	1000	130	210	29/32
T-617-900	1000	130	180	34/35



1.32 Reagent bottles with stopper, transparent

- Made of Quartz



Ordering Information with Specifications:

Catalogue No.	Nominal Capacity (ml)	External Dimensions		
		Socket size	Body Diameter D (mm)	Overall Height H (mm)
T-618-000	60	19/26	44	103
T-618-100	100	19/26	49	120
T-618-200	250	24/29	67	170
T-618-300	500	24/29	82	195
T-618-400	1000	40/38	105	250
T-618-500	2000	40/38	130	275



1.33 Aspirator Bottles with detachable stopcock, transparent

- Made of Quartz

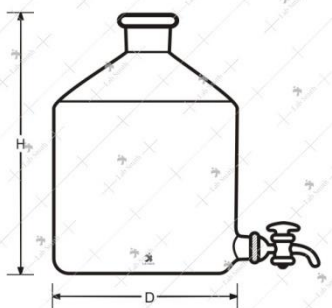

Ordering Information with Specifications:

Catalogue No.	Nominal Capacity (ml)	External Dimensions		
		Socket size	Body Diameter D (mm)	Overall Height H (mm)
T-618-600	500	24/29	92	195
T-618-700	1000	40/38	105	250
T-618-800	2000	40/38	130	275



1.34 Test Tubes with Rim, Transparent

- Made of Quartz



Ordering Information with Specifications:

Catalogue No.	External Dimensions	
	Diameter D (mm)	Overall Height H (mm)
T-618-900	Test Tubes with Rim, Transparent, 10	100
T-619-000	Test Tubes with Rim, Transparent, 12	100
T-619-100	Test Tubes with Rim, Transparent, 14	130
T-619-200	Test Tubes with Rim, Transparent, 16	160
T-619-300	Test Tubes with Rim, Transparent, 18	180
T-619-400	Test Tubes with Rim, Transparent, 20	180
T-619-500	Test Tubes with Rim, Transparent, 25	200
T-619-600	Test Tubes with Rim, Transparent, 30	200



Jainsons India

1.35 Watch Glass, Transparent

- Made of Quartz

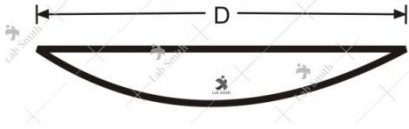

Ordering Information with Specifications:

Catalogue No.	External Dimensions D (mm)
T-619-700	Watch Glass, Transparent, 38
T-619-800	Watch Glass, Transparent, 51
T-619-900	Watch Glass, Transparent, 57
T-620-000	Watch Glass, Transparent, 64
T-620-100	Watch Glass, Transparent, 76
T-620-200	Watch Glass, Transparent, 82
T-620-300	Watch Glass, Transparent, 89
T-620-400	Watch Glass, Transparent, 102



1.36 Petridish (culture) - upper dish, transparent

- Made of Quartz



Ordering Information with Specifications:

Catalogue No.	External Dimensions	
	Diameter D (mm)	Height H (mm)
T-620-500	Petridish (culture) 40 mm	12 mm
T-620-600	Petridish (culture) 50 mm	12 mm
T-620-700	Petridish (culture) 60 mm	12 mm
T-620-800	Petridish (culture) 70 mm	12 mm
T-620-900	Petridish (culture) 80 mm	12 mm
T-621-000	Petridish (culture) 90 mm	12 mm
T-621-100	Petridish (culture) 100 mm	12 mm



1.37 Petri dish (culture) - lower dish transparent

- Made of Quartz



Ordering Information with Specifications:

Catalogue No.	External Dimensions	
	Diameter D (mm)	Height H (mm)
T-621-200	Petri dish (culture) - lower dish transparent 35 mm	15 mm
T-621-300	Petri dish (culture) - lower dish transparent 45 mm	20 mm
T-621-400	Petri dish (culture) - lower dish transparent 55 mm	20 mm
T-621-500	Petri dish (culture) - lower dish transparent 65 mm	20 mm
T-621-600	Petri dish (culture) - lower dish transparent 75 mm	20 mm
T-621-700	Petri dish (culture) - lower dish transparent 85 mm	20 mm
T-621-800	Petri dish (culture) - lower dish transparent 95 mm	20 mm





1.38 Volumetric flasks with sockets transparent BS 1792 – CLASS A

- Made of Quartz

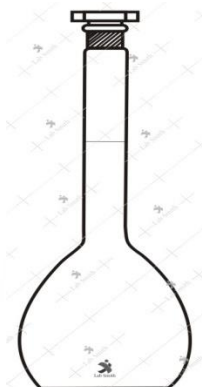

Ordering Information with Specifications:

Catalogue No.	Nominal Capacity (ml)	External Dimensions		
		Tolerance ml	Socket size	Overall Height H (mm)
T-621-900	Volumetric flasks, 5	0.02	7/16	70
T-622-000	Volumetric flasks, 10	0.02	7/16	90
T-622-100	Volumetric flasks, 20	0.04	10/19	110
T-622-200	Volumetric flasks, 25	0.04	10/19	110
T-622-300	Volumetric flasks, 50	0.06	12/21	140
T-622-400	Volumetric flasks, 100	0.10	14/23	170
T-622-500	Volumetric flasks, 200	0.15	14/23	210
T-622-600	Volumetric flasks, 250	0.15	14/23	220
T-622-700	Volumetric flasks, 500	0.25	19/26	260
T-622-800	Volumetric flasks, 1000	0.40	24/29	300
T-622-900	Volumetric flasks, 2000	0.60	29/32	370

Note : Also Available in class B



1.39 Weighing bottles, with interchangeable stopper, tall form, transparent

- Made of Quartz



Ordering Information with Specifications:

Catalogue No.	Nominal Capacity (ml)	Height H (mm)	Diameter D (mm)
T-623-000	Weighing bottles, Tall Form, 10	40	25
T-623-100	Weighing bottles, Tall Form, 20	50	30
T-623-200	Weighing bottles, Tall Form, 45	65	40
T-623-300	Weighing bottles, Tall Form, 45	70	35
T-623-400	Weighing bottles, Tall Form, 70	80	40
T-623-500	Weighing bottles, Tall Form, 110	80	50



1.40 Weighing bottles, with interchangeable stopper, wide form, transparent

- Made of Quartz



Ordering Information with Specifications:

Catalogue No.	Nominal Capacity (ml)	Height H (mm)	Diameter D (mm)
T-623-600	Weighing Bottles, Wide Form, 6	25	25
T-623-700	Weighing Bottles, Wide Form, 15	30	35
T-623-800	Weighing Bottles, Wide Form, 15	25	40
T-623-900	Weighing Bottles, Wide Form, 30	30	50
T-624-000	Weighing Bottles, Wide Form, 45	30	60
T-624-100	Weighing Bottles, Wide Form, 80	30	80



1.41 Quartz Cones B.S. 572/60 Transparent

- Made of Quartz



Ordering Information with Specifications:

Catalogue No.	Cone Size	Bore Diameter d1 (mm)	Outer Dia. d2 (mm)	Overall Length L (mm)
T-624-200	Quartz Cones B.S. 572/60, 5/13	3	4	100
T-624-300	Quartz Cones B.S. 572/60, 7/16	5	7	100
T-624-400	Quartz Cones B.S. 572/60, 10/19	6	8	100
T-624-500	Quartz Cones B.S. 572/60, 12/21	8	10	100
T-624-600	Quartz Cones B.S. 572/60, 14/23	10	12	100
T-624-700	Quartz Cones B.S. 572/60, 19/26	14	17	100
T-624-800	Quartz Cones B.S. 572/60, 24/29	19	22	100
T-624-900	Quartz Cones B.S. 572/60, 29/32	23	26	120
T-625-000	Quartz Cones B.S. 572/60, 34/35	27	30	120
T-625-100	Quartz Cones B.S. 572/60, 40/38	33	37	120
T-625-200	Quartz Cones B.S. 572/60, 45/40	37	41	120
T-625-300	Quartz Cones B.S. 572/60, 50/42	41	45	120
T-625-400	Quartz Cones B.S. 572/60, 55/44	46	50	120
T-625-500	Quartz Cones B.S. 572/60, 60/46	51	55	120
T-625-600	Quartz Cones B.S. 572/60, 65/48	56	60	160
T-625-700	Quartz Cones B.S. 572/60, 70/50	60	64	160
T-625-800	Quartz Cones B.S. 572/60, 75/52	65	69	160
T-625-900	Quartz Cones B.S. 572/60, 80/54	70	74	160
T-626-000	Quartz Cones B.S. 572/60, 85/56	75	79	160
T-626-100	Quartz Cones B.S. 572/60, 90/58	80	84	160
T-626-200	Quartz Cones B.S. 572/60, 95/60	85	89	160
T-626-300	Quartz Cones B.S. 572/60, 100/62	90	94	160



1.42 Sockets, Transparent

- Made of Quartz

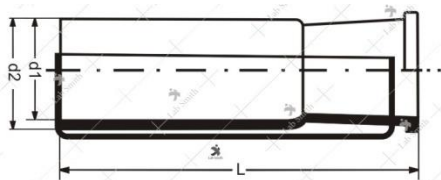

Ordering Information with Specifications:

Catalogue No.	Socket Size	Bore Diameter d1 (mm)	Dia. d2 (mm)	Overall Length L (mm)
T-626-400	Sockets Transparent, 5/13	5	7	100
T-626-500	Sockets Transparent, 7/16	7	9	100
T-626-600	Sockets Transparent, 10/19	10	12	100
T-626-700	Sockets Transparent, 12/21	12	14	100
T-626-800	Sockets Transparent, 14/23	14	16	100
T-626-900	Sockets Transparent, 19/26	19	22	100
T-627-000	Sockets Transparent, 24/29	24	27	100
T-627-100	Sockets Transparent, 29/32	29	32	120
T-627-200	Sockets Transparent, 34/35	34	37	120
T-627-300	Sockets Transparent, 40/38	40	43	120
T-627-400	Sockets Transparent, 45/40	45	49	120
T-627-500	Sockets Transparent, 50/42	50	54	120
T-627-600	Sockets Transparent, 55/44	55	59	120
T-627-700	Sockets Transparent, 60/46	60	64	120
T-627-800	Sockets Transparent, 65/48	65	69	160
T-627-900	Sockets Transparent, 70/50	70	74	160
T-628-000	Sockets Transparent, 75/52	75	79	160
T-628-100	Sockets Transparent, 80/54	80	84	160
T-628-200	Sockets Transparent, 85/56	85	89	160
T-628-300	Sockets Transparent, 90/58	90	94	160
T-628-400	Sockets Transparent, 95/60	95	99	160
T-628-500	Sockets Transparent, 100/62	100	104	160



1.43 Spherical Ground Ball/Cup Joints, Transparent (BS.2761)

- Made of Quartz

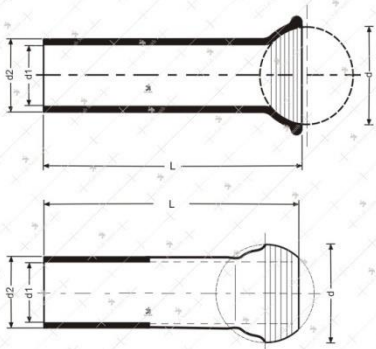

Ordering Information with Specifications:

Catalogue No.	Spherical Dia. D (mm)	Bore Dia. d1 (mm)	Dia. d2 (mm)	Overall Length L (mm)
T-628-600	12.700	5	7	100
T-628-700	12.700	5	7	100
T-628-800	19.050	10	12.5	100
T-628-900	19.050	10	12.5	100
T-629-000	28.575	16	19	100
T-629-100	28.575	16	19	100
T-629-200	34.925	23	26	100
T-629-300	34.925	23	26	100
T-629-400	41.275	27	30	110
T-629-500	41.275	27	30	110
T-629-600	50.800	33	37	110
T-629-700	50.800	33	37	110

Note: Advance by 5 for ball.

e.g. T-628-800 indicate cup for S19

T-628-900 indicate ball for S19



1.44 Hollow Blown Stoppers, Transparent

- Made of Quartz



Ordering Information with Specifications:

Catalogue No.	Joint size
T-629-800	Hollow Blown Stoppers 10/19
T-629-900	Hollow Blown Stoppers 12/21
T-630-000	Hollow Blown Stoppers 14/23
T-630-100	Hollow Blown Stoppers 19/26
T-630-200	Hollow Blown Stoppers 24/29
T-630-300	Hollow Blown Stoppers 29/32
T-630-400	Hollow Blown Stoppers 34/35



1.45 Microscope Slides-Ground & Polished, Transparent

- Made of Quartz



Ordering Information with Specifications:

Catalogue No.	Nominal Dimensions		
	Length L (mm)	Width W (mm)	Thickness T (mm)
T-630-500	25	25	I
T-630-600	50	25	I
T-630-700	75	25	I



1.46 Discs/Plates Ground & Polished, Transparent

- Made of Quartz

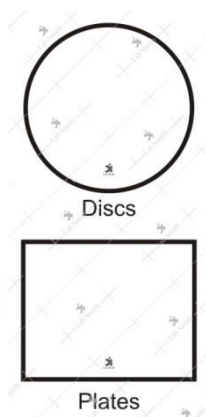

Ordering Information with Specifications:

Catalogue No.	Diameter D (mm)
T-630-800	Discs/Plates Ground & Polished 10 mm
T-630-900	Discs/Plates Ground & Polished 15 mm
T-631-000	Discs/Plates Ground & Polished 20 mm
T-631-100	Discs/Plates Ground & Polished 25 mm
T-631-200	Discs/Plates Ground & Polished 30 mm
T-631-300	Discs/Plates Ground & Polished 35 mm
T-631-400	Discs/Plates Ground & Polished 40 mm
T-631-500	Discs/Plates Ground & Polished 45 mm
T-631-600	Discs/Plates Ground & Polished 50 mm
T-631-700	Discs/Plates Ground & Polished 55 mm
T-631-800	Discs/Plates Ground & Polished 60 mm
T-631-900	Discs/Plates Ground & Polished 65 mm
T-632-000	Discs/Plates Ground & Polished 75 mm
T-632-100	Discs/Plates Ground & Polished 85 mm
T-632-200	Discs/Plates Ground & Polished 100 mm

Note: Available in square & round.
Thickness: 1, 2, 3, 4, 5 & 6 mm standard.
Special sizes on request.
ADD: Thickness value at end while ordering.
e.g. T-630-800-2 indicates 2mm disc of 10mm dia.



1.47 Quartz Rods Transparent

- Made of Quartz



Ordering Information with Specifications:

Catalogue No.	Diameter D (mm)
T-632-300	Quartz Rods Transparent 2 mm
T-632-400	Quartz Rods Transparent 3 mm
T-632-500	Quartz Rods Transparent 4 mm
T-632-600	Quartz Rods Transparent 5 mm
T-632-700	Quartz Rods Transparent 6 mm
T-632-800	Quartz Rods Transparent 7 mm
T-632-900	Quartz Rods Transparent 8 mm
T-633-000	Quartz Rods Transparent 9 mm
T-633-100	Quartz Rods Transparent 10 mm
T-633-200	Quartz Rods Transparent 12 mm
T-633-300	Quartz Rods Transparent 14 mm
T-633-400	Quartz Rods Transparent 15 mm

Note: Tolerance 0.5 mm

**P.S: The above rods are supplied in standard lengths of 1 mtr.
Other sizes & lengths on request.**



1.48 Tubing Quartz Transparent

- Made of Quartz



Ordering Information with Specifications:

Catalogue No.	Nominal Bore (mm)	Nominal External dia. (mm)	Tol. on Bore or External dia.
T-633-500	Tubing Quartz Transparent, 1	3	+ - 0.5
T-633-600	Tubing Quartz Transparent, 2	3	+ - 0.5
T-633-700	Tubing Quartz Transparent, 3	5	+ - 0.5
T-633-800	Tubing Quartz Transparent, 4	6	+ - 0.5
T-633-900	Tubing Quartz Transparent, 5	7	+ - 0.5
T-634-000	Tubing Quartz Transparent, 6	8	+ - 0.5
T-634-100	Tubing Quartz Transparent, 7	9	+ - 0.5
T-634-200	Tubing Quartz Transparent, 8	10	+ - 0.5
T-634-300	Tubing Quartz Transparent, 10	12	+ - 0.5
T-634-400	Tubing Quartz Transparent, 12	14	+ - 0.5
T-634-500	Tubing Quartz Transparent, 14	16	+ - 0.5
T-634-600	Tubing Quartz Transparent, 16	18	+ - 0.8
T-634-700	Tubing Quartz Transparent, 18	21	+ - 0.8
T-634-800	Tubing Quartz Transparent, 19	22	+ - 0.8
T-634-900	Tubing Quartz Transparent, 20	23	+ - 0.8
T-635-000	Tubing Quartz Transparent, 22	25	+ - 0.8
T-635-100	Tubing Quartz Transparent, 25	28	+ - 0.8
T-635-200	Tubing Quartz Transparent, 27	30	+ - 1.0
T-635-300	Tubing Quartz Transparent, 30	33	+ - 1.0
T-635-400	Tubing Quartz Transparent, 32	35	+ - 1.0



Jainsons India

T-635-500	Tubing Quartz Transparent, 35	38	+ - 1.0
Catalogue No.	Nominal Bore (mm)	Nominal External dia. (mm)	Tol. on Bore or External dia.
T-635-600	Tubing Quartz Transparent, 37	40	+ - 1.0
T-635-700	Tubing Quartz Transparent, 40	43	+ - 1.5
T-635-800	Tubing Quartz Transparent, 42	45	+ - 1.5
T-635-900	Tubing Quartz Transparent, 45	48	+ - 1.5
T-636-000	Tubing Quartz Transparent, 50	54	+ - 1.5
T-636-100	Tubing Quartz Transparent, 55	59	+ - 1.5
T-636-200	Tubing Quartz Transparent, 57	61	+ - 1.5
T-636-300	Tubing Quartz Transparent, 60	64	+ - 2.0
T-636-400	Tubing Quartz Transparent, 65	69	+ - 2.0
T-636-500	Tubing Quartz Transparent, 70	74	+ - 2.0
T-636-600	Tubing Quartz Transparent, 75	79	+ - 2.0
T-636-700	Tubing Quartz Transparent, 80	85	+ - 2.0
T-636-800	Tubing Quartz Transparent, 85	89	+ - 2.0
T-636-900	Tubing Quartz Transparent, 90	94	+ - 2.0
T-637-000	Tubing Quartz Transparent, 95	100	+ - 2.0
<p>P.S: The above tubes are supplied in standard lengths of 1000mm. Other sizes & lengths on request.</p>			