



LEVCHEM

SYNTHWARE GLASS



Our contact information:
Levchemglass LTD

Avram Iancu nr 8. Ap 2B 400089 Cluj-Napoca Romania

Phone: +40757427147

E-mail: contact@levchem.com

Internet: www.levchem.com



TABLE OF CONTENTS

A-F

108,109,117,121-128	ACCESSORIES
1-22	ADAPTER
23	BUBBLER
24	BOTTLE, GAS WASHING
25	COLUMN, DISTILLING
26-34	CONDENSER
35	DEWAR FLASK
36-46	CHROMATOGRAPHY
47-56	DISTILLATION
57	EXTRACTOR, SOXHLET
58	EVAPORATOR, KUDERNA-DANISH
59	FILTRATION APPARATUS
60-70	FLASK
71-77	SCHLENK TUBE
77-80,88-94	FUNNEL
78	POWDER
92-94	PRESSURE EQUALIZING
77-80	FILTER
89-91	SEPARATORY

G-T

81	GAS DISPERSION TUBE
86	REACTOR, PHOTOCHEMICAL
87	PRESSURE VESSEL
95-108	MANIFOLD
110-114	TRAP, VACUUM
115-117	SOLVENT STILL
118-120	STOPPER
129-134	STOPCOCK
135-139	HIGH VACUUM VALVE
140-141	SUBLIMATOR
142-149	MICROSCALE
150-153	KIT
150	MICROSCALE
151-153	MACROSCALE

Our contact information:
Levchemglass LTD

Avram Iancu nr 8. Ap 2B 400089 Cluj-Napoca Romania
Phone: +40757427147
E-mail: contact@levchem.com
Internet: www.levchem.com



General Instructions

Glass Properties

All Synthware[®] glass products meets ASTM Specification E438, Type 1, Class A “standard Specification for Glasses in Laboratory Apparatus”. This borosilicate glass with low linear coefficient of expansion is ideal choice for fabricating laboratory glassware.

Annealing Point560°C

Linear Coefficient of Expansion

..... $32 \times 10^{-7}/^{\circ}\text{C}$

Softening Point.....820°C

Trade Marks

Registered trademarks found in this catalog.

Teflon[®]E.I. DuPont.

Viton[®]E.I. DuPont.

Nylon[®]E.I. DuPont.

Rodasis[®]S.A.V. France

Note: The most common US joints are 14/20 and 24/40. These sizes apply only to glassware in the US. There are also European ISO standard joints with common joint sizes of 5/13, 7/16, 10/19, 12/21, 14/23, 19/26, 24/29, 29/32, 34/35, 45/40, 60/46, 71/51 and 85/55. The US and ISO joints differ only in the length, not in the slope, and some can be used in combination. We have both US and European joints available upon your request.

Our contact information:
Levchemglass LTD

Avram Iancu nr 8. Ap 2B 400089 Cluj-Napoca Romania
Phone: +40757427147
E-mail: contact@levchem.com
Internet: www.levchem.com

Dimensions of Joints

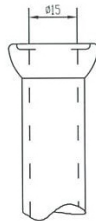
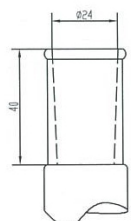
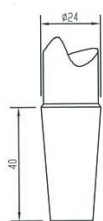

Standard Dimensions for Full Length Interchangeable Taper-Ground Joints

Standard Dimensions for Medium Length Interchangeable Taper-Ground Joints

Joint Size Number (Designation)	Approximate Diameter at Small End mm	Approximate Length of Ground Zone mm	Diameter of large End of Ground Zone mm
7/25	5	25	7.5
10/30	7	30	10.0
12/30	9.5	30	12.5
14/35	11	35	14.5
19/38	15	38	18.8
24/40	20	40	24.0
29/42	25	42	29.2
34/45	30	45	34.5
40/50	35	50	40.0
45/50	40	50	45.0
50/50	45	50	50.0
55/50	50	50	55.0
60/55	55	50	60.0

Joint Size Number (Designation)	Approximate Diameter at Small End mm	Approximate Length of Ground Zone mm	Diameter of large End of Ground Zone mm
5/12	3.8	12	5.0
7/15	6.0	15	7.5
10/18	8.2	18	10.0
12/18	10.7	18	12.5
14/20	12.5	20	14.5
19/22	16.6	22	18.8
24/25	21.5	25	24.0
29/26	26.6	26	29.2
34/28	31.7	28	34.5
40/35	36.5	35	40.0

Standard Dimensions for Short Length Interchangeable Taper-Ground Joints

Standard Dimensions for Interchangeable Spherical Ground Joints

Joint Size Number (Designation)	Approximate Diameter at Small End mm	Approximate Length of Ground Zone mm	Diameter of large End of Ground Zone mm
7/10	6.3	10	7.0
10/10	9.0	10	10.0
14/10	13.5	10	14.5
24/12	22.8	12	24.0
29/12	28.0	12	29.2
34/12	28.0	12	29.2
40/12	38.8	12	40.0
45/12	43.8	12	45.0
50/12	48.8	12	50.0
55/12	53.8	12	55.0
60/12	58.8	12	60.0

Joint Size Number (Designation)	Nominal Diameter of Ball mm	Nominal Tube Inside Diameter mm
21/1	12	1
21/1.5	12	1.5
12/2	12	2
12/3	12	3
12/5	12	5
18/7	18	7
18/9	18	9
28/12	28	12
28/15	28	15
35/20	35	20
35/25	35	25
40/25	40	25
50/30	50	30
65/40	65	40
75/50	75	50

Dimensions for Stopcocks

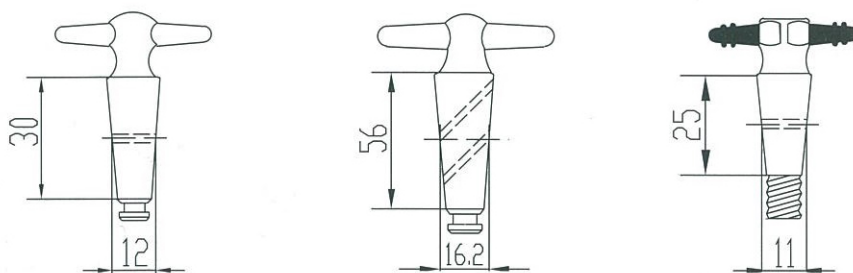

Stopcocks with Glass Plugs

Single Straight-Bore Stopcocks

Stopcock Size (Designation and Bore of Hole in Plug mm)	Diameter of Plug at Centerline of Bore mm	Length of Shell ±0.5 mm
1-m(1mm)	7	30
1	12	30
1-1/2	12	30
2	12	30
3	17	40
4	17	40
5	20	40
6	20	44
8	25	52
10	35	56

Single Oblique-Bore Stopcocks

Stopcock Size (Designation and Bore of Hole in Plug mm)	Diameter of Plug at Opening Nearest Large End mm (Gauging Point)	Distance of Gauging Point Form Large end mm	Length of Shell ±0.5 mm
1	12.60	14.0	40
1-1/2	12.60	14.0	40
2	12.60	14.0	40
3	17.35	16.5	50
4	17.35	16.5	50

T-Bore 120° Bore Stopcocks

Stopcock Size (Designation and Bore of Hole in Plug mm)	Diameter of Plug at Centerline of Bore mm	Length of Shell ±0.5 mm
1	17	40
1-1/2	17	40
2	17	40
3	20	44
4	20	44

Double Oblique-Bore Stopcocks

Stopcock Size (Designation and Bore of Hole in Plug mm)	Diameter of Plug at Gauging Point (Center of Plug) mm	Distance Gauging Point Form Centerline of Hole nearest Large End mm	Length of Shell ±0.5 mm
1	14.5	12.5	50
1-1/2	14.5	12.5	50
2	14.5	12.5	50
3	16.2	14.0	56
4	16.2	14.0	56

Stopcocks with Teflon® Plugs

Single Straight-Bore Stopcocks

Stopcock Size (Designation and Bore of Hole in Plug mm)	Diameter of Plug at Centerline of bore mm	Length of Shell ±0.5 mm
1	11	25
2	11	25
3	15.2	30
4	15.2	30
6	16	35

Single Oblique-Bore Stopcocks

Stopcock Size (Designation and Bore of Hole in Plug mm)	Diameter of Plug at Opening Nearest Large End mm (Gauging Point)	Distance of Gauging Point Form Large end mm	Length of Shell ±0.5 mm
2	15.9	11.5	30

T-Bore 120° Bore Stopcocks

Stopcock Size (Designation and Bore of Hole in Plug mm)	Diameter of Plug at Centerline of bore mm	Length of Shell ±0.5 mm
1	15.2	30
2	15.2	30
4	16	35

Double Oblique-Bore Stopcocks

Stopcock Size (Designation and Bore of Hole in Plug mm)	Diameter of Plug at Opening Nearest Large End mm (Gauging Point)	Distance of Gauging Point Form Large end mm	Length of Shell ±0.5 mm
1	12.9	9.4	44
2	12.9	9.4	44
3	14.4	10.4	44
4	14.4	10.4	44

O-Ring-Organic Solvent Compatibility Chart^{1, 2}

Organic Solvents	Viton®	Chemraz® 505	Chemraz® 514 White
Acetic Acid, Glacial	D	A	B
Acetic Anhydride	B	A	B
Acetone	D	A	A
Acetonitrile	A	A	A
Ammonia, Anhydrous Liquid	D	A	B
Benzene	A	A	A
Benzyl Chloride	A	A	A
Bromine	A	A	A
Butane	A	A	A
Carbon Tetrachloride	A	B	B
Chloroform	A	A	A
Cyclohexane	A	A	A
Decane	A	A	A
Diethyl Ether	D	A	A
Ethanol	C	A	A
Ethyl Acetate	D	A	A
Gasoline	A	A	A
n-Hexane	A	A	A
Isobutyl Alcohol	A	A	A
Kerosene	A	A	A
Methanol	D	A	A
Methyl Ethyl Ketone	D	A	A
Pentane	A	A	A
Propane	A	A	A
Pyridine	D	A	A
Tetrahydrofuran	D	A	A
Toluene	D	A	A

A - Excellent. Volumetric swell is less than 10% after exposure.

B - Good. Limited exposure is recommended.

C - Fair. Volumetric swell is between 20% - 40% after exposure. Limited exposure and frequent O-ring replacements may be necessary.

D - Poor. Not suitable for this type of reaction / condition.

¹. We can not be responsible for use of the above data in specific applications. Immersion testing under actual conditions is always recommended. For specific chemical resistance, please call our office for technical information at 800-472-1658.

². Fluorinated products should never be exposed to molten or gaseous alkali metals such as sodium or potassium, since vigorous exothermic reaction may occur.

ADAPTER, BUSHING

Bushing adapters allow for compact assemblies of dissimilar joints.



Item#	Top Outer Joint	Bottom Inner Joint
A791419	14/20	19/22
A793519	14/35	19/38
A793524	14/35	24/40
A791924	19/38	24/40
A792434	24/40	34/45
A792445	24/40	45/50

ADAPTER, REDUCING

With joints at top and bottom.



Item#	Top Joint	Bottom Joint
A201024	10/30	24/40
A201419	14/20	19/22
A201424	14/20	24/40
A201924	19/22	24/40
A202429	24/40	29/42
A202434	24/40	34/45
A202445	24/40	45/50

ADAPTER, ENLARGING

With joints at top and bottom.



Item#	Top Joint	Bottom Joint
A251914	19/22	14/20
A252414	24/40	14/20
A252419	24/40	19/22
A252914	29/42	14/20
A252924	29/42	24/40
A253424	34/45	24/40
A254024	40/50	24/40
A254529	45/50	29/42



ADAPTER, WITH BALL SOCKET

With top spherical socket joint and lower standard taper inner joint.

Item#	Top Joint	Bottom Joint
A663514	35/20	14/20
A663524	35/20	24/40



ADAPTER, INLET

For use with gas inlet tubes or plain stem thermometers.

Supplied with one holed rubber adapter.

Item#	Joint
A451420	14/20
A451922	19/22
A452440	24/40

Accessory:

R045 Replacement rubber adapter



ADAPTER, INLET OR THERMOMETER

With a compression cap and Viton® O-ring to form a vacuum tight seal.

To use it as a syringe port, simply replace the O-ring with

Teflon® -lined septum. Cap accommodates 5.0 - 7.5mm O.D. thermometer.

Supplied with one Nylon® cap and one Viton® O-ring.

Item#	Joint
A521420	14/20
A521922	19/22
A522440	24/40

Accessories:

RC009 Nylon® caps

R107 Replacement Viton® O-rings, Size 107





ADAPTER, INLET, WITH HOSE CONNECTION

Same as above but with 8mm or 10mm hose connection for N₂/Ar introduction or vacuum. Supplied with one Nylon[®] cap and one Viton[®] O-ring.

Item#	Joint
A531420	14/20
A532440	24/40

Accessories:

- RC009 Nylon[®] caps
- R107 Replacement Viton[®] O-rings, Size 107



ADAPTER, VACUUM OR ARGON

With hose connection on the side and male joint.

Item#	Joint	Hose O.D. (mm)
A291420	14/20	8
A291922	19/22	8
A292440	24/40	10
A292942	29/42	10



ADAPTER, VACUUM/GAS, BALL JOINT

With 35/20 ball joint and 10mm Hose connection.

Item#	Joint
A293520	35/20



ADAPTER, VACUUM OR ARGON (NITROGEN)

With hose connection on the top and male joint.

Item#	Joint	Hose O.D. (mm)
A301420	14/20	8
A301922	19/22	8
A302440	24/40	10
A302942	29/42	10



ADAPTER, VACUUM/INERT GAS, 90°

Item#	Joint	Hose connection O.D. (mm)
A921420	14/20	8
A921922	19/22	8
A922440	24/40	10



ADAPTER, VACUUM, 90°, OUTER JOINT

Item#	Joint	Hose connection O.D. (mm)
A951420	14/20	8
A951922	19/22	8



ADAPTER, INLET

With an extra coarse disc to prevent solid from being introduced into reaction system during liquid transfer.

Item#	Joint	Height (mm)
A831420	14/20	65
A831922	19/22	67
A832440	24/40	95



ADAPTER, TWIN CONNECTING HOSE

Adapter has two hose connections 180° from one another to permit a flow of inert gas over the apparatus.



Item#	Joint	Hose O.D. (mm)
A341420	14/20	8
A341922	19/22	8
A342440	24/40	10
A342942	29/42	10



ADAPTER, VACUUM, OUTER JOINT

Ideal for use as a vent or for the introduction of pressure/vacuum.

Item#	Joint	Hose O.D. (mm)
A321420	14/20	8
A322440	24/40	10



ADAPTER, VACUUM, WITH 1:5 TEFLON® STOPCOCK

With 8mm or 10mm O.D. hose connection and 2mm Teflon® stopcock.

Item#	Joint
A381420	14/20
A381922	19/22
A382440	24/40

Accessory:

S181125 Replacement 2mm Teflon® Plug
Only



ADAPTER, VACUUM, PTFE STOPCOCK

Used to regulate the flow of gases or liquids into reaction systems. Teflon[®] stopcock has a bore of 2mm. With standard taper inner joint.

Item#	Joint	Stopcock Bore (mm)
A701420	14/20	2
A701922	19/22	2
A702440	24/40	2

Accessory:

S181125 Replacement 2mm Teflon[®] Plug Only



ADAPTER, OUTER JOINT, PTFE STOPCOCK

For regulating the flow of gases or liquids into reaction systems. Stopcock has a bore of 2mm. With standard taper outer joint.

Item#	Joint	Stopcock Bore(mm)
A711420	14/20	2
A711922	19/22	2
A712440	24/40	2

Accessory:

S181125 Replacement 2mm Teflon[®] Plug Only



ADAPTER, VACUUM, GLASS STOPCOCK, 90°

Used to regulate the flow of gases or liquids into reaction systems. Stopcock has a bore of 2mm.

Item#	Joint	Stopcock Bore(mm)
A751420	14/20	2
A751922	19/22	2
A752440	24/40	2

Accessories:

S461230 Replacement 2mm Glass Plug Only
S691230 Replacement S.S. Retention for 2mm Glass stopcock



ADAPTER, VACUUM, GLASS STOPCOCK

Used to regulate the flow of gases or liquids into reaction systems. Stopcock has a bore of 2mm.

Item#	Joint	Stopcock Bore(mm)
A611420	14/20	2
A611922	19/22	2
A612440	24/40	2

Accessories:

S461230	Replacement 2mm Glass Plug Only
S691230	Replacement S.S. Retention for 2mm Glass stopcock

ADAPTER, OUTER JOINT, GLASS STOPCOCK

For regulating the input of gases or liquids into reaction systems. With 8mm or 10mm hose connection.

Item#	Joint	Stopcock Bore(mm)
A691420	14/20	2
A692440	24/40	2

Accessories:

S461230	Replacement 2mm Glass Plug Only
S691230	Replacement S.S. Retention for 2mm Glass stopcock

ADAPTER, FLUSHING

With 2mm T-bore PTFE stopcock.

Item#	Joint
A681420	14/20
A681922	19/22
A682440	24/40

Accessory:

S201530	2mm Teflon® "T"-bore Stopcock Plug
---------	------------------------------------



ADAPTER, VACUUM/INERT GAS

With 4mm T-bore glass stopcock having constant pressure retention device or 2mm T-bore 1:5 taper Teflon® plug.

Item#	Joint	Stopcock Type
A881420G	14/20	Glass
A882440G	24/40	Glass
A881420	14/20	Teflon®
A882440	24/40	Teflon®

Accessories:

- S511740 4mm Glass “T”-bore Stopcock Plug
- S201530 2mm Teflon® “T”-bore Stopcock Plug
- S691740 Replacement S.S. Retention for 4mm Glass stopcock



ADAPTER, THERMOMETER

With 10/30 thermometer joint, angled for use in multiple neck flask.

Item#	Joint
A162440	24/40



ADAPTER, INLET

Item#	Joint	Hose O.D.(mm)	Tube Length(mm)
A314075	24/40	10	75
A314250	24/40	10	250





ADAPTER, FLOW CONTROL, METERING STOPCOCK, 90°

Provides on/off control with the main valve. Allows delivery of preset volumes of gases or liquids to reactions using the needle valve.

Item#	Joint	Stopcock Bore(mm)
A721420	14/20	2
A721922	19/22	2
A722440	24/40	2

Accessory:

S191125 Replacement 2mm Teflon® Metering Plug



ADAPTER, FLOW CONTROL, METERING STOPCOCK

Adapter has a 2mm Teflon® metering stopcock between top outer and lower inner standard taper joints to permit flow control of fluids between apparatus.

Item#	Joints	Stopcock Bore(mm)
A732440	24/40	2

Accessory:

S191125 Replacement 2mm Teflon® Metering Plug



ADAPTER, FLUSHING

With 2mm T-bore PTFE stopcock.

Item#	Joints
A761420	14/20
A762440	24/40

Accessory:

S201530 2mm Teflon® "T"-bore Stopcock Plug



ADAPTER, CONNECTING

With 2mm Teflon® stopcock. Converts standard vessels to airless applications.

Item#	Joints
A192424	24/40

Accessory:

S181125 Replacement 2mm Teflon® Plug Only



ADAPTER, VACUUM TRANSFER

With 2mm Teflon® stopcock. For transfer of sensitive and hazardous solutions.

Item#	Joint
A121420	14/20
A121922	19/22
A122440	24/40

Accessory:

S181125 Replacement 2mm Teflon® Plug Only



ADAPTER, INLET WITH HOSE CONNECTION

With vacuum take-off and drip tip.

Item#	Joints	Hose O.D. (mm)
A431420	14/20	8
A431922	19/22	8
A432440	24/40	10





ADAPTER, VACUUM

With 2mm straight-bore PTFE or Glass stopcock.

Item#	Joints	Stopcock Type
A741420	14/20	Teflon®
A741922	19/22	Teflon®
A742440	24/40	Teflon®
A741420G	14/20	GLASS
A741922G	19/22	GLASS
A742440G	24/40	GLASS

Accessories:

- S181125 Replacement 2mm Teflon® Plug Only
- S461230 Replacement 2mm Glass Plug Only Interchangeable
- S691230 Replacement S.S. Retention for 2mm Glass stopcock



ADAPTER, DISTILLATION, BENT, 105°

Also used as rotary evaporator washer. When filled with ethanol or acetone and suddenly with finger released, the mashing solvent is sprayed into the Rotavapor Condenser and thus cleans the entire system very simple and handy.

Item#	Joints
A412440	24/40



ADAPTER, DISTILLING, 105°

With an outer joint at top. Tapered drip tube extends into open receivers.

Item#	Joint	Height × Width, (mm)
A961922	19/22	90×60
A962440	24/40	141×105



ADAPTER, ANTI-CLIMB

Trap provides expanded volume for reactions that have a tendency to foam excessively. The inner vapor tube is sealed to the top of the trap to prevent entry into the condenser.

Item#	Top Joint	Bottom Joint	Capacity (mL)
A272414	24/40	14/20	100
A272419	24/40	19/22	100
A274100	24/40	24/40	100
A272250	24/40	14/20	250
A274250	24/40	24/40	250
A279450	29/42	24/40	250



ADAPTER, DISTILLING TRAP

Adapter is placed above flask to prevent carry-over of reactions which have a tendency to foam.

Item#	Upper Joint	Lower Joint	Capacity (mL)
A262414	24/40	14/20	100
A262419	24/40	19/22	100
A264100	24/40	24/40	100



ADAPTER, ANTI-SPLASH

This design prevents possible contamination from rotary evaporator.



Item#	Upper Joint	Lower Joint	Capacity (mL)
A282414	24/40	14/20	100
A282419	24/40	19/22	100
A282424	24/40	24/40	100
A282914	29/42	14/20	100
A282924	29/42	24/40	100
A281250	24/40	14/20	250
A289250	24/40	19/22	250
A284250	24/40	24/40	250
A282250	29/42	24/40	250
A288250	29/42	29/42	250



ADAPTER, ANTI-SPLASH, WITH FRITTED DISC

Similar to A28 except with extra coarse fritted disc sealed above lower inner joint. Frit reduces foam from being carryover.

Item#	Upper Joint	Lower Joint	Capacity(mL)
A232414	24/40	14/20	100
A232419	24/40	19/22	100
A232424	24/40	24/40	100
A231250	24/40	14/20	250
A234250	24/40	24/40	250



VAPOR DUCT, ROTARY EVAPORATOR

Precision ground and polished. Meet manufacturer's standards. Please call with your rotary evaporator model.

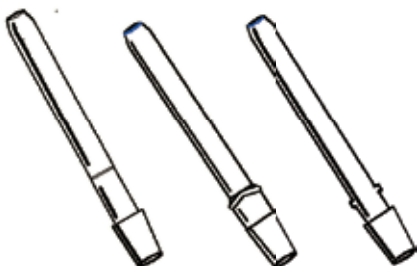

Item#	Joint
V222440	24/40
V222440L	24/40
V222440H	24/40



ADAPTER, ANTI-SPLASH, MODIFIED

With two 4mm drain holes at the base of the inner tube to allow solvent to drain back into the evaporation flask.

Item#	Upper Joint	Lower Joint	Capacity (mL)
A602414	24/40	14/20	100
A602419	24/40	19/22	100
A602424	24/40	24/40	100
A602914	29/42	14/20	100
A602924	29/42	24/40	100
A601250	24/40	14/20	250
A604250	24/40	24/40	250



ADAPTER, ANTI-SPLASH, WITH FRITTED DISC

Similar to A60 except with extra coarse fritted disc sealed above lower inner joint. Frit reduces foam overflow from being drawn into the condenser.

Item#	Upper Joint	Lower Joint	Capacity (mL)
A462414	24/40	14/20	100
A462424	24/40	24/40	100
A461250	24/40	14/20	250
A464250	24/40	24/40	250





GROUND JOINT, REDUCED DIAMETER, EXTENDED, DRIP TUBE

Inner joint with a sealed on lower tube extending 6" below the grind, having the same O.D. tubing on both ends of the grind.

Item#	Joint	Length below Joint (mm)	Tubing O.D. (mm)
A501420	14/20	153	8
A501922	19/22	153	10
A502440	24/40	153	12



ADAPTER, TRANSFER VALVE

The 0-4mm high vacuum valves have two Viton® O-rings on the shaft and an integral PTFE O-ring on the tip.

Item#	Joints	Overall Height × Width, (mm)
A391420	14/20	150×75
A392440	24/40	180×75

Accessory:

S600004 0-4mm high vacuum plug and control knob. (PTFE O-ring at tip)



ADAPTER, DRYING TUBE, "U" SHAPED

With joint. Cotton is usually used to contain drying agent.

Item#	Joint
A851420	14/20
A851922	19/22
A852440	24/40



ADAPTER, DRYING TUBE, STRAIGHT

With top and bottom joints.

Item#	Joints
A861420	14/20
A861922	19/22
A862440	24/40



ADAPTER, DRYING TUBE, 75°

Angled at 75° to avoid desiccant contact with reactions.

Item#	Joint
A871420	14/20
A871922	19/22
A872440	24/40



ADAPTER, DISTILLATION CONNECTING

For use as a component in atmospheric or vacuum distillations.

Item#	Top Joint	Bottom Joint	Side Joint	Immersion (Bottom of top joint to bottom of side hole) (mm)
A351014	10/18	14/20	14/20	50
A351019	10/18	19/22	19/22	50
A351024	10/18	24/40	24/40	76
A351420	14/20	14/20	14/20	—
A351922	19/22	19/22	19/22	—
A352440	24/40	24/40	24/40	—
A351424	14/20	24/40	24/40	—
A354914	14/20	24/40	19/22	—



THERMOMETER, WITH 10/18 JOINT

Immersion length is measured from the bottom of 10/18 joint to lower end of mercury bulb. Accuracy is $\pm 1^{\circ}\text{C}$.



Item#	Immersion (mm)	Range ($^{\circ}\text{C}$)
T162511	25	-20 to 110
T162525	25	-20 to 250
T162532	25	-20 to 320
T165011	50	-20 to 110
T165025	50	-20 to 250
T165032	50	-20 to 320
T167611	76	-20 to 110
T167625	76	-20 to 250
T167632	76	-20 to 320

ADAPTER, DISTILLING, 75 $^{\circ}$

With compression cap (RC009) and Viton[®] O-ring for forming a vacuum tight seal of plain thermometer.



Item#	Joints	Height x Width (mm)
A971420	14/20	110x55
A971922	19/22	110x55
A972440	24/40	155x100

Accessories:

- RC009 Nylon[®] cap
- R107 Replacement Viton[®] O-rings, size 107

ADAPTER, DISTILLING, BENT, 105 $^{\circ}$

With an inner drip joint at the bottom and an outer joint at the top.



Item#	Top Joint	Bottom Joint
A891420	14/20	14/20
A891922	19/22	19/22
A892440	24/40	24/40



ADAPTER, INLET, LONG STEM

With standard taper top outer and lower inner joints with sealed in lower tube extending below inner joint.

Item#	Joints	Tube Length Below Joint(mm)
A651420	14/20	100
A652440	24/40	200



ADAPTER, VACUUM TAKE-OFF, SHORT STEM

With a hose connection and a drip tip.

Item#	Joints	Hose connection (mm)
A621420	14/20	8
A621922	19/22	8
A622440	24/40	10
A622942	29/42	10



ADAPTER, DISTILLATION HEAD

Vacuum jacketed. The 10/18 top joint accommodates a 76mm immersion thermometer.

Item#	Top Joint	Other Joints
A542440	10/18	24/40

Accessory:

T167625 76mm Immersion thermometer
-20 °C to 250 °C





ADAPTER, DISTILLATION CONNECTING, VIGREUX

Accommodate a 76mm immersion thermometer.

Item#	Top Joint	Other Joint	Side Joint
A131024	10/18	24/40	24/40

Accessory:

T167625 76mm Immersion thermometer
 -20 °C to 250 °C



ADAPTER, DISTILLATION

With threaded thermometer port, supplied complete with Nylon® cap (RC009) and Viton® O-ring to (R107) accommodate 6-7.5mm O.D. plan thermometer.

Item#	Joints
A901420	14/20
A901922	19/22
A902440	24/40

Accessories:

RC009 Nylon® cap
 R107 Replacement Viton® O-rings, size 107



ADAPTER, DISTILLATION

With a 10/18 joint on the vertical side tube for a 76mm immersion thermometer.

Item#	All Joints	Thermometer Joint
A362410	24/40	10/18

Accessory:

T167625 76mm Immersion thermometer
 -20 °C to 250 °C



ADAPTER, CLAISEN

Provides dual entry into a variety of flasks.

Item#	Joints
A371420	14/20
A371922	19/22
A372440	24/40
A372942	29/42



ADAPTER, CONNECTING

Three-arm design for the assembly of three vessels.

Item#	Joints
A331420	14/20
A332440	24/40



ADAPTER, CLAISEN

Three-inlet type for multiple entries into a single neck flask.
One side joint is at a 45° angle.

Item#	Joints
A111420	14/20
A112440	24/40





ADAPTER, CONNECTING

Three-arm design for the assembly of three vessels.

Item#	Joints
A101420	14/20
A102440	24/40



ADAPTER, BENT, 75°

With inner joints at each end.

Item#	Joints
A151420	14/20
A151922	19/22
A152440	24/40



ADAPTER, VACUUM FILTRATION

Used with plain stem Buchner funnels and pluro-stopper. Hose connection has an O.D of 10mm at the largest serration. Order pluro-stoppers below separately.

Item#	Lower Joint	Pluro-stopper size	Fits Funnel Capacity (mL)
A841420	14/20	#1	2 to 30
A842415	24/40	#3	15 to 150
A842440	24/40	#5 or #6	350 to 3000



ADAPTER, WITH MINERAL OIL BUBBLER

With 10mm O.D. hose connection.

Item#	Joint
A402440	24/40



ADAPTER, VACUUM DISTILLING

Distance between joints is 100mm. Useful in the sub-boiling separation of mixtures having volatile components.

Item#	Joints	Hose O.D. (mm)
A491420	14/20	8



ADAPTER, U-SHAPE

Item#	Joints
A631420	14/20



ADAPTER, KJELDAHL TRAP

Distance between center of joints is approximate 200mm.

Item#	Joints
A172440	24/40





BUBBLER, MINERAL OIL

With 10mm O.D. hose connection.

Item#	Body O.D. (mm)	Overall Height x Width (mm)
B257040	26	185x80
B257040L	26	500x80



BUBBLER

With small ball joints to prevent mineral oil being sucked back under sudden negative pressure in the system.

Item#	Top Joint	Bottom Joint	Length (mm)
B262914	29/42	14/20	157
B262924	29/42	24/40	157

Accessory:

S181125 Replacement 2mm Teflon® Plug Only



BUBBLER

With small ball joints to prevent mineral oil being sucked back under sudden negative pressure in the system.

Item#	Top Joint	Bottom	Length(mm)
B262910	29/42	10mm Hose connection	157

Accessory:

S181125 Replacement 2mm Teflon® Plug Only



BOTTLE, GAS WASHING, FRITTED DISC

Gas washing bottle with standard taper 45/50 cap style stopper and fritted disc angled at 15° for even distribution of gas throughout absorbing material.

Available with a coarse or extra coarse fritted disc.

Order plastic clip separately. (not supplied)

Complete Bottles:

Item#	Capacity (mL)	Approx. Height (mm)	Porosity
B300125C	125	290	C
B300125X	125	290	XC
B300250C	250	305	C
B300500C	500	380	C
B300500X	500	380	XC

Accessory:

CS004550 Plastic Clamp, 45/50



BOTTLE, GAS WASHING, FRITTED DISC

Gas washing bottle with an extra large diameter (60mm) fritted disc sealed into the bottom of the bottle to enable increased gas throughput and uniform gas distribution. Available with coarse fritted disc. The 24/40 standard taper top outer joint accepts a A292440 gas inlet adapter which is supplied with bottle.

Complete Bottles:

Item#	Capacity (mL)	Approx. Height (mm)	Porosity
B310350C	350	250	C

Replacement Components:

Item#	Description
A292440	Adapter, 24/40 Gas Inlet Adapter, 8mm hose connection
CS002440	24/40 Joint clip, plastic





COLUMN, DISTILLING, VIGREUX

Column length is measured from the highest to lowest indent in the column.

Item#	Indentation Length (mm)	Upper Joint	Lower Joint
C101075	75	14/20	14/20
C101100	100	14/20	14/20
C101420	120	14/20	14/20
C101922	120	19/22	19/22
C109130	130	19/22	19/22
C102441	120	24/40	24/40
C104150	150	24/40	24/40
C102442	200	24/40	24/40
C102443	300	24/40	24/40



CONDENSER, DISTILLATION, VACUUM JACKETED

With 12mm I.D. indentations to support packing material. Vacuum jacketed to improve performance .

Item#	Joints	Jacket Height (mm)
C161100	14/20	130
C164250	24/40	250



DISTILLING COLUMN PACKING

It is a particle type mini-glass coils packing and can be “poured” into any laboratory or pilot scale column. Easily removed for replacement or cleaning.

Item#	Material	Size O.D.×L(mm)
D240001	Glass	4×12



CONDENSER, DISTILLATION

Indentations at the bottom for supporting packing material.
Jacket permits the column to be used as a condenser.

Item#	Joints	Jacket Height (mm)	Column Overall Height(mm)
C171120	14/20	110	180
C171200	14/20	200	280
C179110	19/22	110	200
C179200	19/22	200	280
C174200	24/40	200	330

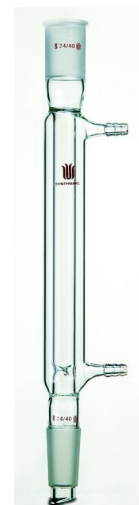

CONDENSER, DISTILLATION, REMOVABLE HOSE CONNECTIONS

Indentations at the bottom for supporting packing material. Jacket permits the column to be used as a condenser.

Item#	Joints	Jacket Height (mm)	Column Overall Height(mm)
C571120	14/20	110	180
C571200	14/20	200	280
C579110	19/22	110	200
C574200	24/40	200	330

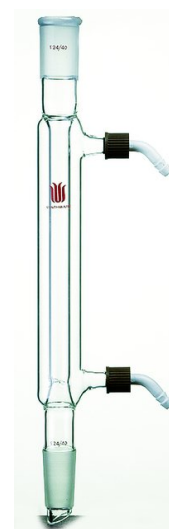

Accessories:

- RC14 #14 Nylon® cap with 9.5mm hole
- R201402 Replacement hose connection-Straight

CONDENSER, FRIEDRICHS, WITH 24/40 JOINT

With a joint at 15° angle.

Item#	Top Joint	Bottom Joint	Over Height (mm)
C212440	24/40	24/40	330
C214550	24/40	45/50	340





CONDENSER, FRIEDRICHS, REMOVABLE HOSE CONNECTIONS

With a joint at 15° angle. Supplied completely with Nylon® cap and hose connections.

Item#	Top Joint	Bottom Joint	Over Height (mm)	Hose Connection (mm)
C272440	24/40	24/40	330	10

Accessories:

- RC14 #14 Nylon® cap with 9.5mm hole
- R201402 Replacement hose connection-straight

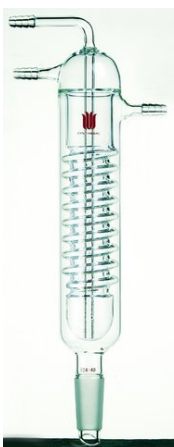

CONDENSER, FRIEDRICHS

Item#	Joint	Overall Height (mm)	Hose Connection (mm)
C232440	24/40	330	10



CONDENSER, COLD FINGER, WITH DRIP TIP

Extended offset lower tip for drop control.

Item#	Joint	Length Below Joint(mm)	Hose O.D.(mm)
C111420	14/20	100	8
C114150	24/40	150	10
C114200	24/40	200	10
C114250	24/40	250	10



CONDENSER, REFLUX

Coil style reflux condenser with tightly wrapped coil providing maximum cooling. Excellent for use with volatile solvents. Condenser has a top outer standard taper joint and lower inner drip tip joint. Hose connections have an O.D. of 8mm or 10mm at the middle serration.

Item#	Jacket Length (mm)	Joints	Overall Height (mm)	Hose Connection (mm)
C261100	100	14/20	205	8
C262280	180	14/20	305	8
C269100	125	19/22	205	8
C264125	125	24/40	275	10
C264175	175	24/40	325	10
C264225	225	24/40	375	10
C264275	275	24/40	425	10

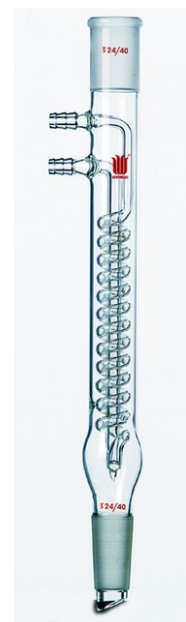

CONDENSER, REFLUX, REMOVABLE HOSE CONNECTIONS

Coil style reflux condenser with tightly wrapped coil providing maximum cooling. Excellent for use with volatile solvents. Condenser has a top outer standard taper joint and lower inner drip tip joint.

Item#	Jacket Length (mm)	Joints	Overall Height (mm)	Hose Connection (mm)
C561100	100	14/20	210	8
C562280	180	14/20	305	8
C564125	125	24/40	285	10
C564175	175	24/40	335	10
C564225	225	24/40	375	10



Accessories:

- RC14 #14 Nylon® cap with 9.5mm hole
- R201402 Replacement hose connection-Straight

CONDENSER, COILED

With joints at top and bottom.



Item#	Jacket Length (mm)	Joints	O.D. Hose Connection(mm)
C121100	100	14/20	8
C121120	120	14/20	8
C129200	200	19/22	8
C124200	200	24/40	10
C124300	300	24/40	10
C124400	400	24/40	10

CONDENSER, COILED, REMOVABLE HOSE CONNECTIONS

With joints at top and bottom.



Item#	Jacket Length (mm)	Joints	O.D. Hose Connection (mm)
C524200	200	24/40	8
C524300	300	24/40	8
C524400	400	24/40	8
C528300	300	29/42	8

Accessories:

- RC14 #14 Nylon® cap with 9.5mm hole
- R201402 Replacement hose connection-Straight

CONDENSER, GRAHAM



Item#	Joints	Jacket Length(mm)	O.D. Hose Connection(mm)
C141120	14/20	120	8
C149200	19/22	200	8
C144200	24/40	200	8
C144250	24/40	250	10
C144300	24/40	300	10
C144400	24/40	400	10



CONDENSER WEST, REMOVABLE HOSE CONNECTIONS

With narrow annular space for high cooling efficiency.

Item#	Joints	Jacket Length(mm)
C551110	14/20	110
C550190	14/20	190
C554100	24/40	100
C551190	24/40	190
C554200	24/40	200
C554300	24/40	300

Accessories:

- RC14 #14 Nylon® cap with 9.5mm hole
- R201402 Replacement hose connection-Straight



CONDENSER WEST

With narrow annular space for fast coolant speed, thus high cooling efficiency.

Item#	Joints	Jacket Length(mm)
C151110	14/20	110
C150190	14/20	190
C151200	14/20	200
C159190	19/22	190
C159200	19/22	200
C154100	24/40	100
C151190	24/40	190
C154200	24/40	200
C154300	24/40	300

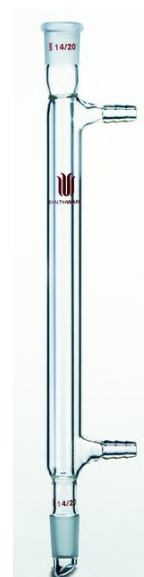

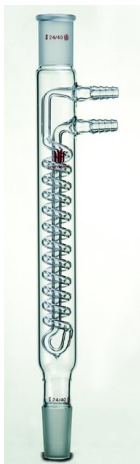

CONDENSER, REFLUX, LARGE COOLING CAPACITY

Jacket has an O.D. of 40mm while coil O.D. is 8mm to provide maximum cooling capacity.

Item#	Coil Length (mm)	Joints	Overall Height(mm)	Hose Connection (mm)
C314125	125	24/40	300	10
C314175	175	24/40	350	10



CONDENSER, REFLUX, LARGE COOLING CAPACITY, REMOVABLE HOSE CONNECTIONS

Jacket has an O.D. of 40mm while coil O.D. is 8mm to provide maximum cooling capacity.

Item#	Coil Length (mm)	Joints	Overall Height (mm)	Hose Connection (mm)
C534125	125	24/40	300	8

Accessories:

- RC14 #14 Nylon® cap with 9.5mm hole
- R201402 Replacement hose connection-straight

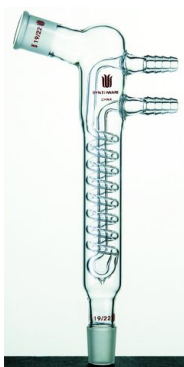

CONDENSER, REFLUX

Coil section is 100mm in height.

Item#	Joints
C351420	14/20
C351922	19/22



CONDENSER, ALLIHN

With joints at the top and the bottom.

Item#	Jacket Length (mm)	Joints	O.D. Hose Connection (mm)
C251120	120	14/20	8
C259200	200	19/22	8
C259300	300	19/22	8
C251200	200	24/40	10
C254300	300	24/40	10
C254400	400	24/40	10
C255300	300	29/42	10
C255400	400	29/42	10



CONDENSER, ALLIHN, REMOVABLE HOSE CONNECTIONS

With joints at the top and the bottom.

Item#	Jacket Length (mm)	Joints	O.D. Hose Connection (mm)
C621120	120	14/20	8
C621200	200	24/40	8
C624300	300	24/40	8
C624400	400	24/40	8
C625300	300	29/42	8



Accessories:

- RC14 #14 Nylon® cap with 9.5mm hole
- R201402 Replacement hose connection-straight

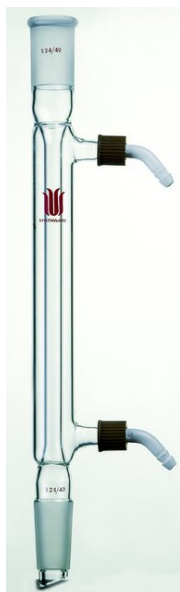
CONDENSER, LIEBIG, REMOVABLE HOSE CONNECTIONS

With joints at the top and the bottom.

Item#	Jacket Length (mm)	Joints	O.D. Hose Connection (mm)
C501120	120	14/20	8
C509180	180	19/22	8
C509300	300	19/22	8
C504200	200	24/40	8
C504250	250	24/40	8
C504300	300	24/40	8
C504400	400	24/40	8
C504500	500	24/40	8

Accessories:

RC14 #14 Nylon® cap with 9.5mm hole

R201402 Replacement hose connection-straight

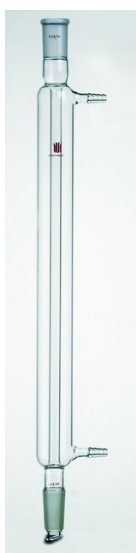
CONDENSER, LIEBIG

With joints at the top and the bottom.

Item#	Jacket Length (mm)	Joints	O.D. Hose Connection (mm)
C201120	120	14/20	8
C209180	180	19/22	8
C209300	300	19/22	8
C204100	100	24/40	10
C204200	200	24/40	10
C204250	250	24/40	10
C204300	300	24/40	10
C204400	400	24/40	10
C204500	500	24/40	10

CONDENSER, DEWAR, MICRO

Side joint is at 90° angle.

Item#	Inside Depth(mm)	I.D.(mm)	Joints
C341014	90	31	14/20



CONDENSER, FOR ROTARY EVAPORATORS

Double coil condenser for use with Buchi rotary evaporators for cooling with tap water in a diagonal position. A 19/38 top valve. With 35/20 spherical ball joint.

Item#	Description
C910200	Rotary Evaporator Condenser, diagonal style

Accessories:

- C910001 Inlet feed tube
- RC14 Nylon® cap for water inlet/outlet
- R201402 Replacement Nylon® hose connection-straight, with O-ring(used with RC14 cap)
- RC18 Nylon® cap for vacuum
- R201801 Replacement Nylon® hose connection-straight, with O-ring(used with RC18 cap)



CONDENSER, FOR ROTARY EVAPORATOR, UPRIGHT STYLE

For vertical style of Heidforfe.

Item#	Description
C900200	Rotary Evaporator Condenser, vertical style

Accessories:

- C900001 Inlet feed tube, 19/38 joint
- RC14 Nylon® cap
- R201402 Replacement hose connection-straight





FLASK, DEWAR, LOW FORM, HEMISPHERICAL

Flask size shown is the maximum capacity flask that will fit inside the Dewar. With Aluminum housing to transfer magnetic field.



Item#	Fits Flask Sizes (mL)	Interior Dimensions, Depth× Diameter (mm)
F240100	100	65×80
F240250	250	75×100
F240500	500	85×123
F241000	1000	100×143

***Due to extra high vacuum, the Dewar flasks still have a rare possibility to explode, so working behind a safety shield in hood and always wearing goggles are strongly recommended.**

FLASK, DEWAR, WIDE MOUTH, METAL HOUSING

Dewar flask with weighted metal base for stability and with a full-length aluminum housing which extends to the top rim for added protection.



Item#	Overall Capacity (mL)	Exterior Dimensions in Height×Width (mm)	Interior Dimensions in Depth×Diameter (mm)
F110350	350	157×86	125×70
F110665	665	241×86	195×70
F111000	1000	337×86	302×70
F111900	1900	252×160	190×120
F111900L	3500	337×160	302×120
F114300	4300	365×178	305×143

***Due to extra high vacuum, the Dewar flasks still have a rare possibility to explode, so working behind a safety shield in hood and always wearing goggles are strongly recommended.**

CHROMATOGRAPHY FLOW CONTROL ADAPTER

0-4mm high vacuum valve with metering tip to adjust air pressure. With standard taper joint. Order CC3525 pinch type clamps with screw-locking device for ball joints.

For replacement O-rings on high vacuum plug shaft, order R010. The O-rings on the high vacuum PTFE valve are completely encapsulated with thin layer of PTFE, making it inert to chemicals.

Item#	Joint Size
-------	------------

C1301	35/20
-------	-------

C1324	24/40
-------	-------

Accessories:

S660004	0-4mm high vacuum metering plug and control knob. (PTFE O-ring at tip)
---------	--

R010	Replacement Viton® O-rings, size 010 for 0-4mm high vacuum plug shaft O-ring
------	--

CC3525	Clamps for 35/20 or 35/25 ball joint
--------	--------------------------------------

CS002440	Plastic clamp for 24/40 joint
----------	-------------------------------



* Since the chromatography column is used with positive air pressure, it's highly recommended that operator uses column behind a safety shield.

CHROMATOGRAPHY RESERVOIR

For flash chromatography.

Item#	joints	Capacity(mL)
C184100	24/40	100
C182402	24/40	250
C182403	24/40	500
C193502	35/20	250
C193503	35/20	500

Accessories:

CC3525	S.S. Clamps for 35/20 or 35/25 ball joint
--------	---

CS002440	Plastic clamp for 24/40 joint
----------	-------------------------------



CHROMATOGRAPHY COLUMN, HEAVY WALL DESIGN

General purpose column has a Teflon® stopcock and a top outer joint.

For flash chromatography. All Synthware columns are heavy wall designed to increase safety.



Item#	Column O.D. (mm)	Column I.D. (mm)	Effective Length inch(mm)	Joint	Stopcock Bore (mm)
C184171	17	13.4	8(203)	24/40	2
C184172	17	13.4	10(254)	24/40	2
C184173	17	13.4	12(305)	24/40	2
C184261	26	20.0	8(203)	24/40	2
C184262	26	20.0	10(254)	24/40	2
C184263	26	20.0	12(305)	24/40	2
C184264	26	20.0	18(457)	24/40	2
C184321	32	26.0	8(203)	24/40	2
C184322	32	26.0	10(254)	24/40	2
C184323	32	26.0	12(305)	24/40	2
C184324	32	26.0	18(457)	24/40	2
C184461	46	40.0	8(203)	24/40	2
C184462	46	40.0	10(254)	24/40	2
C184463	46	40.0	12(305)	24/40	2
C184464	46	40.0	18(457)	24/40	2
C184603	60	53.0	12(305)	24/40	4
C184604	60	53.0	18(457)	24/40	4
C184605	60	53.0	24(610)	24/40	4

Accessories:

- CS002440 Plastic clamp for 24/40 joint
- S181125 Replacement 2mm Teflon® Plug Only
- S181530 Replacement 4mm Teflon® Plug Only

* Since the chromatography column is used with positive air pressure, it's highly recommended that operator uses column behind a safety shield.

TLC DEVELOPING TANKS – CYLINDRICAL

Made of glass with lid. Compact size offers good plate visibility and minimal solvent use.



Item#	OD*H (mm)	Joint
T216105	65*105	60/12
T216205	65*205	60/12



CHROMATOGRAPHY COLUMN, HEAVY WALL DESIGN

General purpose column has a Teflon® stopcock and a top outer joint.
 With a coarse porosity fritted disc to support column packing. The section below disc is carefully minimized to prevent re-mixing of components already separated.
 All Synthware columns are heavy wall designed to increase safety.

Item#	Column O.D. (mm)	Column I.D. (mm)	Effective Length Inch(mm)	Joint	Stopcock Bore (mm)
C184171C	17	13.4	8(203)	24/40	2
C184172C	17	13.4	10(254)	24/40	2
C184173C	17	13.4	12(305)	24/40	2
C184261C	26	20.0	8(203)	24/40	2
C184262C	26	20.0	10(254)	24/40	2
C184263C	26	20.0	12(305)	24/40	2
C184264C	26	20.0	18(457)	24/40	2
C184321C	32	26.0	8(203)	24/40	2
C184322C	32	26.0	10(254)	24/40	2
C184323C	32	26.0	12(305)	24/40	2
C184324C	32	26.0	18(457)	24/40	2
C184461C	46	40.0	8(203)	24/40	2
C184462C	46	40.0	10(254)	24/40	2
C184463C	46	40.0	12(305)	24/40	2
C184464C	46	40.0	18(457)	24/40	2
C184602C	60	53.0	10(254)	24/40	4
C184603C	60	53.0	12(305)	24/40	4
C184604C	60	53.0	18(457)	24/40	4
C184605C	60	53.0	24(610)	24/40	4

Accessories:

- CS002440 Plastic clamp for 24/40 joint
- S181125 Replacement 2mm Teflon® Plug Only
- S181530 Replacement 4mm Teflon® Plug Only

* Since the chromatography column is used with positive air pressure, it's highly recommended that operator uses column behind a safety shield.



COLUMN, CHROMATOGRAPHY WITH RESERVOIR

With 24/40 outer joint at top. All Synthware columns are heavy wall designed to increase safety.



Item#	Column O.D. (mm)	Column I.D. (mm)	Effective Length Inch(mm)	Joint	PTFE Stopcock Bore(mm)	Capacity of Reservoir (mL)
C371720	17	13.4	8(203)	24/40	2	100
C371730	17	13.4	12(305)	24/40	2	100
C371740	17	13.4	18(457)	24/40	2	250
C372620	26	20.0	8(203)	24/40	2	250
C372625	26	20.0	10(254)	24/40	2	250
C372630	26	20.0	12(305)	24/40	2	250
C372640	26	20.0	18(457)	24/40	2	500
C373220	32	26.0	8(203)	24/40	2	500
C373225	32	26.0	10(254)	24/40	2	500
C373230	32	26.0	12(305)	24/40	2	500
C373240	32	26.0	18(457)	24/40	2	500
C374620	46	40.0	8(203)	24/40	2	500
C374625	46	40.0	10(254)	24/40	2	500
C374630	46	40.0	12(305)	24/40	2	500
C374640	46	40.0	18(457)	24/40	2	500
C376025	60	53.0	10(254)	24/40	4	500
C376030	60	53.0	12(305)	24/40	4	1000
C376040	60	53.0	18(457)	24/40	4	1000
C378020	80	73.0	8(203)	24/40	4	1000
C378040	80	73.0	18(457)	24/40	4	1000

Accessories:

- CS002440 Plastic clamp for 24/40 joint
- S181125 Replacement 2mm Teflon® Plug Only
- S181530 Replacement 4mm Teflon® Plug Only

* Since the chromatography column is used with positive air pressure, it's highly recommended that operator uses column behind a safety shield.

COLUMN, CHROMATOGRAPHY WITH RESERVOIR, FRITTED DISC

With a coarse porosity sealed in fritted disc to support column packing.

All Synthware columns are heavy wall designed to increase safety.

Item#	Column O.D. (mm)	Column I.D. (mm)	Effective Length Inch (mm)	Joint	PTFE Stopcock Bore(mm)	Capacity of Reservoir (mL)
C391720C	17	13.4	8(203)	24/40	2	100
C391730C	17	13.4	12(305)	24/40	2	100
C391740C	17	13.4	18(457)	24/40	2	250
C392620C	26	20.0	8(203)	24/40	2	250
C392625C	26	20.0	10(254)	24/40	2	250
C392630C	26	20.0	12(305)	24/40	2	250
C392640C	26	20.0	18(457)	24/40	2	500
C393220C	32	26.0	8(203)	24/40	2	500
C393225C	32	26.0	10(254)	24/40	2	500
C393230C	32	26.0	12(305)	24/40	2	500
C393240C	32	26.0	18(457)	24/40	2	500
C394620C	46	40.0	8(203)	24/40	2	500
C394625C	46	40.0	10(254)	24/40	2	500
C394630C	46	40.0	12(305)	24/40	2	500
C394640C	46	40.0	18(457)	24/40	2	500
C396020C	60	53.0	8(203)	24/40	4	500
C396025C	60	53.0	10(254)	24/40	4	500
C396030C	60	53.0	12(305)	24/40	4	1000
C396040C	60	53.0	18(457)	24/40	4	1000
C396060C	60	53.0	24(610)	24/40	4	1000
C398020C	80	73.0	8(203)	24/40	4	1000
C398025C	80	73.0	10(254)	24/40	4	1000
C398030C	80	73.0	12(305)	24/40	4	1000
C398060C	80	73.0	24(610)	24/40	4	1000

Accessories:

CS002440	Plastic clamp for 24/40 joint
S181125	Replacement 2mm Teflon® Plug Only
S181530	Replacement 4mm Teflon® Plug Only

* Since the chromatography column is used with positive air pressure, it's highly recommended that operator uses column behind a safety shield.



CHROMATOGRAPHY COLUMN, SPHERICAL JOINTS

Spherical joint used with pinch clamp makes quick and tight connection under pressure for flash chromatography. All Synthware columns are heavy wall designed to increase safety.



Item#	Column O.D. (mm)	Column I.D. (mm)	Effective Length Inch(mm)	Joint	PTFE Stopcock Bore (mm)
C195173	17	13.4	12(305)	35/20	2
C195264	26	20.0	18(457)	35/20	2
C195323	32	26.0	12(305)	35/20	2
C195324	32	26.0	18(457)	35/20	2
C195464	46	40.0	18(457)	35/20	2

Accessories:

- CC3525 Clamps for 35/20 ball joint
- S181125 Replacement 2mm Teflon® Plug Only

CHROMATOGRAPHY COLUMN, FRITTED DISC, SPHERICAL JOINTS

With a coarse porosity fritted disc to support packing material. All Synthware columns are heavy wall designed to increase safety.



Item#	Column O.D. (mm)	Column I.D. (mm)	Effective Length Inch(mm)	Joint	PTFE Stopcock Bore (mm)
C195171C	17	13.4	8(203)	35/20	2
C195172C	17	13.4	10(254)	35/20	2
C195173C	17	13.4	12(305)	35/20	2
C195262C	26	20.0	10(254)	35/20	2
C195264C	26	20.0	18(457)	35/20	2
C195323C	32	26.0	12(305)	35/20	2
C195324C	32	26.0	18(457)	35/20	2
C195463C	46	40.0	12(305)	35/20	2
C195464C	46	40.0	18(457)	35/20	2

Accessories:

- CC3525 Clamps for 35/20 ball joint
- S181125 Replacement 2mm Teflon® Plug Only

* Since the chromatography column is used with positive air pressure, it's highly recommended that operator uses column behind a safety shield.

COLUMN, CHROMATOGRAPHY WITH RESERVOIR

With 35/20 spherical joint.

Item#	Column O.D. (mm)	Column I.D. (mm)	Effective Length Inch(mm)	Joint	PTFE Stopcock Bore(mm)	Capacity of Reservoir(mL)
C381720	17	13.4	8(203)	35/20	2	100
C381730	17	13.4	12(305)	35/20	2	100
C381740	17	13.4	18(457)	35/20	2	250
C382620	26	20.0	8(203)	35/20	2	250
C382625	26	20.0	10(254)	35/20	2	250
C382630	26	20.0	12(305)	35/20	2	250
C382640	26	20.0	18(457)	35/20	2	500
C383220	32	26.0	8(203)	35/20	2	500
C383225	32	26.0	10(254)	35/20	2	500
C383230	32	26.0	12(305)	35/20	2	500
C383240	32	26.0	18(457)	35/20	2	500
C384630	46	40.0	12(305)	35/20	2	500
C384640	46	40.0	18(457)	35/20	2	500

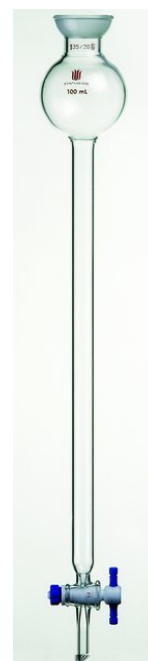

Accessories:

- CC3525 Clamps for 35/20 ball joint
 S181125 Replacement 2mm Teflon® Plug Only

* Since the chromatography column is used with positive air pressure, it's highly recommended that operator uses column behind a safety shield.

COLUMN, CHROMATOGRAPHY WITH RESERVOIR, FRITTED DISC

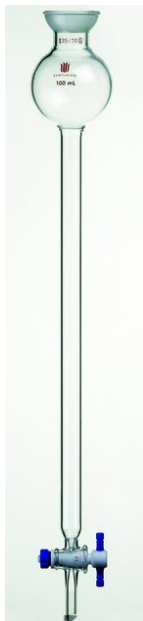
With a coarse porosity fritted disc to support packing ,with 35/20 spherical joint. All Synthware columns are heavy wall designed to increase safety.



Item#	Column O.D. (mm)	Column I.D. (mm)	Effective Length Inch(mm)	Joint	PTFE Stopcock Bore(mm)	Capacity of Reservoir(mL)
C381720C	17	13.4	8(203)	35/20	2	100
C381730C	17	13.4	12(305)	35/20	2	100
C381740C	17	13.4	18(457)	35/20	2	250
C382620C	26	20.0	8(203)	35/20	2	250
C382625C	26	20.0	10(254)	35/20	2	250
C382630C	26	20.0	12(305)	35/20	2	250
C382640C	26	20.0	18(457)	35/20	2	500
C383220C	32	26.0	8(203)	35/20	2	500
C383225C	32	26.0	10(254)	35/20	2	500
C383230C	32	26.0	12(305)	35/20	2	500
C383240C	32	26.0	18(457)	35/20	2	500
C384630C	46	40.0	12(305)	35/20	2	500
C384640C	46	40.0	18(457)	35/20	2	500

Accessories:

CC3525 Clamps for 35/20 ball joint

S181125 Replacement 2mm Teflon® Plug Only

* Since the chromatography column is used with positive air pressure, it's highly recommended that operator uses column behind a safety shield.

CHROMATOGRAPHY COLUMN, MODIFIED

Short column with lower 24/40 joint and hose connection for vacuum. All Synthware columns are heavy wall designed to increase safety.

Item#	Column O.D.(mm)	Length*(mm)	Porosity
F234020C	40	200	Coarse
F234030C	40	300	Coarse
F234030M	40	300	Medium
F236040C	60	400	Coarse
F238530C	90	300	Coarse
F238540C	90	400	Coarse

* Length above fritted disc.

COLUMN, CHROMATOGRAPHY, TEFLON® STOPCOCK

With reinforced beaded top. All Synthware columns are heavy wall designed to increase safety.

Item#	Column O.D. (mm)	Column I.D. (mm)	Effective Length Inch(mm)	PTFE Stopcock Bore (mm)
C361320	13	10.0	8(203)	2
C361330	13	10.0	12(305)	2
C361340	13	10.0	16(406)	2
C361720	17	13.4	8(203)	2
C361725	17	13.4	10(254)	2
C361730	17	13.4	12(305)	2
C362620	26	20.0	8(203)	2
C362625	26	20.0	10(254)	2
C362630	26	20.0	12(305)	2
C362640	26	20.0	18(457)	2
C363225	32	26.0	10(254)	2
C364640	46	40.0	18(457)	2
C366030	60	53.0	12(305)	4
C366040	60	53.0	18(457)	4
C366060	60	53.0	24(610)	4
C368030	80	73.0	12(305)	4

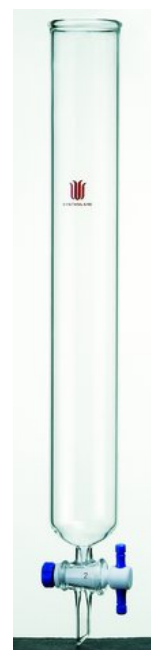
Accessories:

S181125 Replacement 2mm Teflon® Plug Only

S181530 Replacement 4mm Teflon® Plug Only

* Since the chromatography column is used with positive air pressure, it's highly recommended that operator uses column behind a safety shield.

COLUMN, CHROMATOGRAPHY, TEFLON® STOPCOCK, FRITTED DISC

With reinforced beaded top, coarse porosity fritted disc to support column packing.

All Synthware columns are heavy wall designed to increase safety.

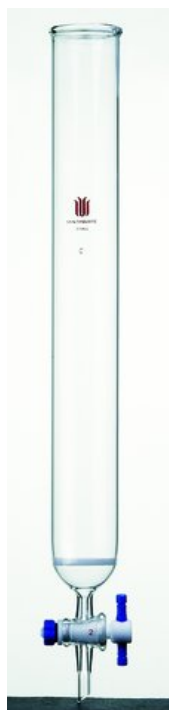

Item#	Column O.D. (mm)	Column I.D. (mm)	Effective Length Inch (mm)	PTFE Stopcock Bore (mm)
C361720C	17	13.4	8(203)	2
C361725C	17	13.4	10(254)	2
C361730C	17	13.4	12(305)	2
C361740C	17	13.4	18(457)	2
C362620C	26	20.0	8(203)	2
C362625C	26	20.0	10(254)	2
C362630C	26	20.0	12(305)	2
C362640C	26	20.0	18(457)	2
C363225C	32	26.0	10(254)	2
C363230C	32	26.0	12(305)	2
C363240C	32	26.0	18(457)	2
C364620C	46	40.0	8(203)	2
C364625C	46	40.0	10(254)	2
C364630C	46	40.0	12(305)	2
C364640C	46	40.0	18(457)	2
C366040C	60	53.0	18(457)	4
C366060C	60	53.0	24(610)	4
C368030C	80	73.0	12(305)	4

Accessories:

S181125 Replacement 2mm Teflon® Plug Only

S181530 Replacement 4mm Teflon® Plug Only

* Since the chromatography column is used with positive air pressure, it's highly recommended that operator uses column behind a safety shield.

FLOW CONTROL ADAPTER, CHROMATOGRAPHY, RODAVISS® JOINT

Flow control adapter for use with column with 24/40 or 45/50 inner Rodaviss® joint. Supplied complete with open top screw cap, loosening cap and O-ring. Adapter has a 0-4mm metering plug.

Item	Joint
C432440	24/40

Accessories:

- RC2440 24/40 Open Top Screw Cap
- R202440 24/40 Loosening Ring
- R221 #221 O-Rings for 24/40 Rodaviss® Joint
- S660004 0-4mm high vacuum metering plug and control knob.
(PTFE O-ring at tip)
- R010 Replacement Viton® O-rings, size 010

*Since the chromatography column is used with positive air pressure, it's highly recommended that operator uses column behind a safety shield.

RESERVOIR, CHROMATOGRAPHY, RODAVISS® JOINT

Reservoir has a top 24/40 or 45/50 Rodaviss® outer joint for use with flow controller, and the listed size lower inner joint. Supplied complete with open top cap, Viton® O-ring and loosening ring.

Item#	Capacity (mL)	Lower Inner Joint Size
C414250	250	24/40
C414500	500	24/40

Accessories:

- RC2440 24/40 Open Top Screw Cap
- R202440 24/40 Loosening Ring
- R221 #221 O-Rings for 24/40 Rodaviss® Joint

*Since the chromatography column is used with positive air pressure, it's highly recommended that operator uses column behind a safety shield.



DISTILLING BULB, KUGELROHR

Used in distillation of very small amount of distillate at lower temperature with high efficiency. Kugelrohr machine required but not supplied.

For the vacuum adapter, see A301420



Item#	Capacity (mL)	Joints	Bulb O.D. (mm)	Overall Height (mm)
D281005	5	14/20	25	80
D281010	10	14/20	31	85
D281015	15	14/20	35	90
D281025	25	14/20	42	98
D281050	50	14/20	48	105
A301420	14/20 vacuum adapter with 8mm hose connection			

DISH, CRYSTALLIZING, WITH SPOUTS

Top of each dish is reinforced and fire polished to reduce chipping.



Item#	Approx. Dia. × Height (mm)	Approx. Capacity (mL)
D290170	80×45	150
D290700	115×65	500
D291200	140×75	900

DISTILLATION APPARATUS, MICROSCALE

Short-path design for microscale application, used with 25mm immersion thermometer, and D27 distillation receiver.



Item#	Thermometer Joint	Joints
D151814	10/18	14/20
D151819	10/18	19/22



DISTILLATION RECEIVER, WITHOUT HOSE CONNECTION

With the outer and inner joint at 135° angle, used with short-path.

Item#	Joints
D271420	14/20
D272440	24/40



DISTILLATION APPARATUS, MICROSCALE, VIGREUX

With Vigreux Indentations, used with 25mm immersion thermometer, and D27 distillation receiver.

Item#	Thermometer Joint	Joints
D251014	10/18	14/20
D251019	10/18	19/22



DISTILLATION APPARATUS, SHORT PATH, VACUUM JACKETED

Vacuum jacketed design for more efficiency. When a thermometer is inserted in the top of this apparatus, the bulb and stem serve as column packing. The close coupled condenser and vacuum connection offer an extremely short condensate travel path. Used with 25mm immersion thermometer, and D27 distillation receiver.

Item#	Thermometer Joint	Joints
D121014	10/18	14/20





DISTILLING RECEIVER

Supplied with distribution adapter, three 12mL receiver tubes and three plastic joint clip. With 135° angle between top outer joint and lower inner joint.

Item#	Lower Inner Joint Size
D381412	14/20

Accessories:

- T230012 Receiver Tube, 14/20, 12mL
- CS001420 Plastic clamp for 14/20 joint

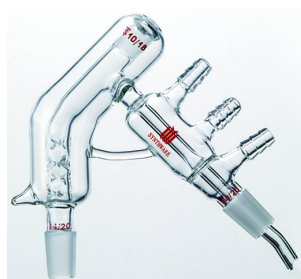

DISTILLATION APPARATUS, SHORT PATH, VACUUM JACKETED

Used with 25mm immersion thermometer, and D27 distillation receiver.

Item#	Thermometer Joint	Joints
D371418	10/18	14/20



DISTILLATION, SHORT PATH WITH 24/40 JOINT

One-piece design for easy set-up. For the best result, use D272440 distillation receiver. To be used with 25mm immersion thermometer.

Item#	Thermometer Joint	Joints
D261024	10/18	24/40



DISTILLING HEAD, SHORT PATH, FOR VOLATILE SOLVENTS

With the condenser being a combination of a cold coil and Leibig. Top outer joint is a 10/18 for use with a 50mm immersion thermometer. For best result, use D272440.

Item#	Lower Inner Joint Size	Top Thermometer Joint
D531024	24/40	10/18



DISTILLING HEAD, SHORT PATH, FOR VOLATILE DISTILLANTS

Same as above, but with Vigreux Indentations. Top outer joint is a 10/18 for use with a 50mm immersion thermometer.

Item#	Lower Inner Joint Size	Top Thermometer Joint
D541024	24/40	10/18



DISTILLING HEAD

Thermometer joint is 10/18 for 76mm immersion thermometer.
Side arm is at 75° angle.

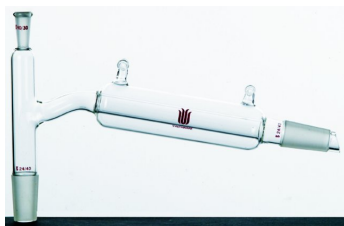

Item#	Lower Inner Joint Size	Top Thermometer Joint	Jacket Length (mm)
D304150	24/40	10/18	150
D304250	24/40	10/18	250
D304400	24/40	10/18	400



DISTILLATION RECEIVER, WITH HOSE CONNECTION

Cow-type design having three receivers spaced 40° apart. 105° angle between top outer joint and lower inner joints.

Item#	Joints
D681420	14/20
D681922	19/22
D682440	24/40



DISTILLATION COW RECEIVER

Designed for microscale application. With one female joint and four drip-tip male joints.

Item#	Joints
D161420	14/20



DISTILLING RECEIVER, GRADUATED, WITH HOOKS

Centrifuge tube shaped receiver with an upper standard taper joint.

Item#	Joint	Capacity(mL)
T230012	14/20	12
T230015	14/20	15



DISTILLING, COW RECEIVER, GRADUATED

Tubes are graduated from 0-3mL in 0.2mL subdivisions.

Item#	Joint
D351403	14/20



DISTILLATION RECEIVER, WITH HOSE CONNECTION

Cow-type design having three receivers spaced 40° apart. 105° angle between top outer joint and lower inner joints.

Item#	Joints
D191420	14/20
D191922	19/22
D192440	24/40



DISTILLATION APPARATUS, VACUUM

10/18 joint on side tube accommodates 25mm immersion thermometer.

Item#	Joints	Other Joints
D101410	10/18	14/20
D101910	10/18	19/22
D101414	14/20	14/20





DISTILLATION RECEIVING SET

Designed without hose connection to be used with D10 distillation apparatus.

Item#	Item Type	Joints
A581420	Vacuum Adapter	14/20
D201414	Cow Receiver	14/20
A581922	Vacuum Adapter	19/22
D201922	Cow Receiver	19/22

Accessories:

- CS001420 Plastic clamp for 14/20 joint
- CS001922 Plastic clamp for 19/22 joint



DISTILLATION RECEIVING SET

Rotating cow receiver allows four flasks to be progressively filled.

Item#	Item Type	Joints
A551420	Distribution Adapter	14/20
D201414	Cow Receiver	14/20
A551922	Distribution Adapter	19/22
D201922	Cow Receiver	19/22
A552440	Distribution Adapter	24/40
D202424	Cow Receiver	24/40

Accessories:

- CS001420 Plastic clamp for 14/20 joint
- CS001922 Plastic clamp for 19/22 joint
- CS002440 Plastic clamp for 24/40 joint



DISTRIBUTION RECEIVER, VERTICAL ORIENTATION

Rotating distillation receiver allows four fractions to be collected.

Vacuum adapter has a vertical orientation.

Item#	Item Type	Joints
A592440	Vacuum Adapter	24/40
D202424	Cow Receiver	24/40

Accessory:

- CS002440 Plastic clamp for 24/40 joint



DISTILLATION HEAD, VIGREUX, MICRO

Distillation head with condenser sealed to a Vigreux column.

Vacuum adapter has an outer joint and accepts a distribution adapter (D201414).

To be used with a 25mm immersion thermometer

Item#	Joint Size	Thermometer joint	Approx. Height×Width (mm)
D141014	14/20	10/18	195×185

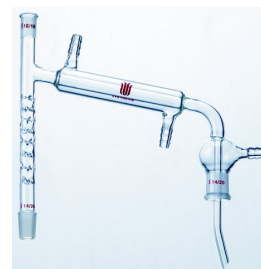

DISTILLATION HEAD, JACKETED, VIGREUX, MICRO

Similar to D14 but with the Vigreux column vacuum jacketed to improve distillation performance. To be used with D201414 distribution adapter.

Item#	Joint Size	Thermometer joint	Approx. Height ×Width (mm)
D171014	14/20	10/18	195×190

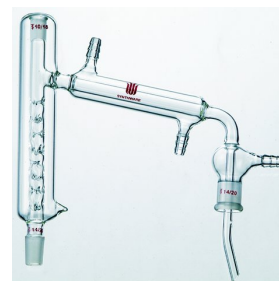

DISTILLATION HEAD, VIGREUX, JACKETED

Vacuum jacketed Vigreux distillation head having a sealed on condenser, braced for strength.

Vacuum adapter has an inner joint and a sealed in drip tip.

To be used with a 25mm immersion thermometer

Item#	Joints	Column Height (mm)	Thermometer joint	Approx. Height×Width (mm)
D211100	14/20	100	10/18	200×180
D211150	14/20	150	10/18	250×180
D214200	24/40	200	10/18	325×350
D214300	24/40	300	10/18	425×350



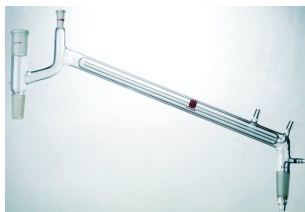

DISTILLATION APPARATUS, LARGE SCALE

One-piece design. With 10/18 thermometer joint and high efficiency cooling jacket. To be used with 50mm immersion thermometer with 10/18 joint.

Item#	Joints
D502440	24/40



DRYING CHAMBER, ABDERHALDEN

Drying samples for elemental analysis. Sample is placed in a vial which is placed into drying chamber. Under vacuum and gentle heat created by refluxing in outer jacket of low boiling point solvents.

Item#	Upper Joint	Lower Joint	Drying Chamber Joint
D222434	24/40	24/40	34/45



DESICCANT FLASK

Choice of Teflon® stopcock.

Item#	Joint	Stopcock
D133424	34/45	2mm (PTFE)

Accessory:

S181125 Replacement 2mm Teflon® Plug Only

**DISTILLATION HEAD, MICROSCALE**

With 2mm glass stopcock and 24/40 joint. Supplied with a special 25mL long-neck flask for small volume efficiency.

Item#	Joints	Hose O.D. mm
D112440G	24/40	10

Accessories:

DF302425	Flask, round bottom, long neck 25mL
S461230	Replacement 2mm Glass Plug Only

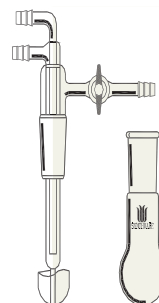
**DISTILLATION RECEIVER, DEAN STARK**

For easy separation of water from reaction or distillation system.

Graduated with 2mm Teflon[®] stopcock or 2mm glass stopcock.

Item#	Capacity (mL)	Joints	Stopcock (mm)	Approx. Height×Width (mm)
D451414	5	14/20	2, PTFE	205×65
D451410	10	14/20	2, PTFE	190×65
D451910	10	19/22	2, PTFE	190×75
D452410	10	24/40	2, PTFE	275×95
D452424	20	24/40	2, PTFE	325×95
D452910	10	29/42	2, PTFE	275×95
D452920	20	29/42	2, PTFE	325×95

Accessories:

S181125	Replacement 2mm Teflon [®] Plug Only
---------	---

**DISTILLATION RECEIVER, DEAN STARK**

Similar to D451414 above but with the uptake tube vacuum jacketed to improve distillation performance. The jacket eliminates the possibility of condensation or recrystallization of distillate in the sidearm. With 2mm PTFE stopcock.

Item#	Capacity (mL)	Joints	Stopcock (mm)	Approx. Height×Width (mm)
D441405	5	14/20	2, PTFE	205×65
D441410	10	14/20	2, PTFE	190×65
D442410	10	24/40	2, PTFE	275×95
D442420	20	24/40	2, PTFE	275×95

Accessory:

S181125	Replacement 2mm Teflon [®] Plug Only
---------	---



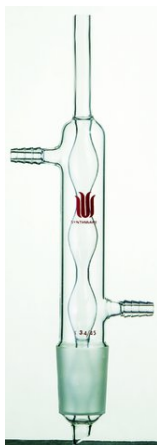

CONDENSER, FOR SOXHLET EXTRACTORS

Allihn reflux condenser with a water cooled inner drip joint at bottom.

Item#	Jacket Length (mm)	Joint	Overall Height (mm)
C243445	190	34/45	275
C244500	260	45/50	365
C245550	300	55/50	405



EXTRACTOR, SOXHLET

Extractor body only.

Item#	Upper Joint	Lower Joint
E103424	34/45	24/40
E104524	45/50	24/40
E105550	55/50	24/40

EXTRACTION THIMBLE, GLASS

All glass extraction thimble permits viewing extraction process and subsequent weighing. C-Coarse, XC-Extra Coarse. Small thimble is used with **C243445** and **E103424**; Medium thimble is used with **C244500** and **E104524**; Large thimble is used with **C245550** and **E105550**.



Item#	Fits Extractor Size	O.D.× Height (mm)	Porosity
E112585C	Small	25×85	C
E112585X	Small	25×85	XC
E113590C	Medium	35×90	C
E113590X	Medium	35×90	XC
E114513C	Large	45×130	C
E114513X	Large	45×130	XC



SNYDER DISTILLATION COLUMN

For use with Kuderna-Danish flask.

Item#	Joints	Column Height (mm)	Overall Height (mm)
C302440	24/40	150	300



KUDERNA-DANISH FLASK

Top joint is a 24/40 outer while the lower joint is a 19/22 inner.

Item#	Flask Capacity (mL)
F984250	250
F984500	500

Accessories:

- CS001922 Plastic clamp for 19/22 joint
- CS002440 Plastic clamp for 24/40 joint



CONCENTRATOR TUBE, GRADUATED

Graduated concentrator tubes for use with Kuderna-Danish evaporative set-ups. Tube can be stoppered for storage. Overall height is 100mm for 10mL, and 170mm for the 25mL.

Item#	Capacity (mL)	Joint Size	Subdivisions (mL)
C291910	10	19/22	0 to 1mL in 0.1, 2 to 10mL in 1.0
C291925	25	19/22	0 to 1mL in 0.1, 2 to 25mL in 1.0



FILTRATION APPARATUS, 47MM FRITTED, 40/35

Using 47mm membranes for filtering corrosive solutions, particulate removal from HPLC solvents, and filtration analysis with solid phase extraction disks. Support base has a sealed-in coarse porosity fritted disc. Complete assembly includes a 300mL graduated funnel, aluminum clamp, support base and 1 liter filtering flask.



Item#	Description
F10401L	Complete Support Assembly

Replacement Components:

F100001	Funnel, 47mm, 300mL Graduated
F100002	Clamp, 47mm aluminum
F100003	Base, 47mm Fritted Support, 40/35
F100004	Flask, 1L Filtering, 40/35

FILTRATION APPARATUS, 47MM STAINLESS STEEL, 40/35

Using 47mm membranes for filtering corrosive solutions, particulate removal from HPLC solvents, and filtration analysis with solid phase extraction disks. Support base has removable 47mm stainless steel support screen for use with viscous or proteinaceous solutions. Complete assembly includes a 300mL graduated funnel, aluminum clamp, support base and 1 liter filtering flask.



Item#	Description
F10401LA	Complete Support Assembly

Replacement Components:

F100001	Funnel, 47mm, 300mL Graduated
F100002	Clamp, 47mm aluminum
F100003A	Base, 47mm SS Screen Support
F100004	Flask, 1L Filtering, 40/35
F100007	Stainless Steel Screen for base support





FLASK, ROUND BOTTOM, SINGLE NECK

Heavy wall design. All sizes listed below are hand-blown from tubing to ensure uniform wall thickness.

Item#	Capacity (mL)	Joint
F301405	5	14/20
F301410	10	14/20
F301910	10	19/22
F301425	25	14/20
F301925	25	19/22
F302425	25	24/40
F301450	50	14/20
F301950	50	19/22
F302450	50	24/40
F301100	100	14/20
F309100	100	19/22
F304100	100	24/40
F308100	100	29/42
F301200	200	14/20
F309200	200	19/22
F304200	200	24/40
F309250	250	19/22
F304250	250	24/40
F308250	250	29/42
F301300	300	14/20
F309300	300	19/22
F304300	300	24/40
F309500	500	19/22
F304500	500	24/40
F308500	500	29/42
F303450	500	34/45
F304000	1000	24/40
F30291L	1000	29/42
F30242L	2000	24/40
F30292L	2000	29/42
F30452L	2000	45/50



FLASK, FLAT BOTTOM

Heavy wall single neck, flat bottom flask with an outer joint.
Heavy wall design. All sizes listed below are hand-blown from tubing to ensure uniform wall thickness.



Item#	Capacity (mL)	Joint
F122450	50	24/40
F124100	100	24/40
F124125	125	24/40
F124250	250	24/40
F124300	300	24/40
F124500	500	24/40
F124000	1000	24/40
F128000	1000	29/42



FLASK, ROUND BOTTOM, SPHERICAL JOINT

Heavy wall design. All sizes listed below are hand-blown from tubing to ensure uniform wall thickness.

Item#	Capacity (mL)	Joint
F527500	500	35/20
F527000	1000	35/20
F52702L	2000	35/20



FLASK, ROUND BOTTOM, THREADED INLET

With a threaded side port for insertion of thermometer or bleed tubes, having an O.D. between 5mm and 7.5mm. Heavy wall design. All sizes listed below are hand-blown from tubing to ensure uniform wall thickness.

Item#	Capacity (mL)	Joint
F141425	25	14/20
F141450	50	14/20
F149100	100	19/22
F144100	100	24/40
F141250	250	14/20
F149250	250	19/22
F144250	250	24/40
F144500	500	24/40

Accessories:

- RC009 Nylon® cap
- R107 Replacement Viton® O-rings, Size 107



FLASK, ROUND BOTTOM WITH HOOKS

Heavy wall design.

Item#	Capacity (mL)	Joint
F331405	5	14/20
F331410	10	14/20
F331425	25	14/20
F331450	50	14/20
F339100	100	19/22

Accessory:

- TH018 S.S. Springs, 18mm



FLASK, RECOVERY

Heavy wall design. All sizes listed below are hand-blown from tubing to ensure uniform wall thickness.



Item#	Capacity (mL)	Joint
F311405	5	14/20
F311410	10	14/20
F311910	10	19/22
F311425	25	14/20
F311925	25	19/22
F312425	25	24/40
F311450	50	14/20
F311950	50	19/22
F312450	50	24/40
F311100	100	14/20
F319100	100	19/22
F314100	100	24/40
F318100	100	29/42
F311200	200	14/20
F314200	200	24/40
F311250	250	14/20
F319250	250	19/22
F314250	250	24/40
F318250	250	29/42
F314500	500	24/40
F318500	500	29/42
F314000	1000	24/40
F31291L	1000	29/42

FLASK, EVAPORATION

Low profile design sits upright on bench and also provides for easy product access with a spatula. The unique flask shape is excellent for the controlled evaporation of foaming solvents such as toluene or xylene on a rotary evaporator.



Item#	Capacity (mL)	Joint
F791450	50	14/20
F791100	100	14/20
F794100	100	24/40
F794200	200	24/40
F791250	250	14/20
F794250	250	24/40
F798250	250	29/42
F794500	500	24/40
F794000	1000	24/40



FLASK, PEAR SHAPED, SINGLE NECK

Heavy wall design.

Item#	Capacity(mL)	Joint
F321405L	5	14/20
F321410L	10	14/20
F321415L	15	14/20
F321225L	25	14/20
F329225L	25	19/22
F321250L	50	14/20
F329250L	50	19/22
F322450L	50	24/40
F321100L	100	14/20
F329100L	100	19/22
F324100L	100	24/40
F321200L	200	14/20
F324200L	200	24/40



FLASK, TWO NECK, PEAR SHAPED

Pear shape with joints. Heavy wall design.

Item#	Capacity (mL)	Center Joint	Side Joint
F341105	5	14/20	14/20
F341110	10	14/20	14/20
F341115	15	14/20	14/20
F341125	25	14/20	14/20
F341150	50	14/20	14/20
F341100	100	14/20	14/20
F341200	200	14/20	14/20



FLASK, TWO NECK, ANGLED

Round bottom with joints. Heavy wall design. All sizes listed below are hand-blown from tubing to ensure uniform wall thickness.



Item#	Capacity (mL)	Center Joint	Side Joint
F411110	10	14/20	14/20
F411125	25	14/20	14/20
F411925	25	19/22	14/20
F419925	25	19/22	19/22
F411150	50	14/20	14/20
F419950	50	19/22	19/22
F414150	50	24/40	14/20
F414450	50	24/40	24/40
F411100	100	14/20	14/20
F411900	100	19/22	14/20
F419900	100	19/22	19/22
F414100	100	24/40	14/20
F419100	100	24/40	19/22
F414400	100	24/40	24/40
F411250	250	14/20	14/20
F410250	250	19/22	14/20
F419250	250	19/22	19/22
F414251	250	24/40	14/20
F414259	250	24/40	19/22
F414250	250	24/40	24/40
F411501	500	19/22	14/20
F414501	500	24/40	14/20
F414504	500	24/40	24/40
F415501	500	29/42	24/40
F415502	500	29/42	29/42
F41611L	1000	24/40	14/20
F41621L	1000	24/40	19/22
F41241L	1000	24/40	24/40
F41641L	1000	29/42	29/42

FLASK, THREE NECK, ANGLED

Round bottom with joints. Heavy wall design. All sizes listed below are hand-blown from tubing to ensure uniform wall thickness.

Item#	Capacity (mL)	Center Joint	Side Joint
F431110	10	14/20	14/20
F431125	25	14/20	14/20
F439925	25	19/22	19/22
F431150	50	14/20	14/20
F439150	50	19/22	14/20
F439950	50	19/22	19/22
F434150	50	24/40	14/20
F434950	50	24/40	19/22
F434450	50	24/40	24/40
F431100	100	14/20	14/20
F439100	100	19/22	14/20
F439900	100	19/22	19/22
F434100	100	24/40	14/20
F434900	100	24/40	19/22
F434400	100	24/40	24/40
F431250	250	14/20	14/20
F430250	250	19/22	14/20
F439250	250	19/22	19/22
F432250	250	24/40	19/22
F434250	250	24/40	24/40
F431500	500	14/20	14/20
F439500	500	19/22	19/22
F430500	500	24/40	19/22
F434500	500	24/40	24/40
F434524	500	45/50	24/40
F43401L	1000	24/40	24/40
F431045	1000	45/50	24/40
F43242L	2000	24/40	24/40
F43542L	2000	45/50	24/40



FLASK, THREE NECK, VERTICAL

Round bottom with joints. Heavy wall design. All sizes listed below are hand-blown from tubing to ensure uniform wall thickness.



Item#	Capacity (mL)	Center Joint	Side Joint
F441150	50	14/20	14/20
F449950	50	19/22	19/22
F441100	100	14/20	14/20
F449100	100	19/22	14/20
F449900	100	19/22	19/22
F444100	100	24/40	14/20
F444900	100	24/40	19/22
F444400	100	24/40	24/40
F441250	250	14/20	14/20
F442250	250	24/40	19/22
F444250	250	24/40	24/40
F441500	500	14/20	14/20
F449500	500	19/22	19/22
F440500	500	24/40	19/22
F444500	500	24/40	24/40
F446500	500	29/42	24/40
F448500	500	29/42	29/42
F444000	1000	24/40	24/40
F44841L	1000	29/42	24/40
F44341L	1000	34/45	24/40
F44451L	1000	45/50	24/40
F44242L	2000	24/40	24/40
F44842L	2000	29/42	24/40
F44292L	2000	29/42	29/42
F44342L	2000	34/45	24/40
F44542L	2000	45/50	24/40



FLASK, ROUND BOTTOM, 4-NECK, ANGLED

Heavy wall design. All sizes listed below are hand-blown from tubing to ensure uniform wall thickness.

Item#	Capacity (mL)	Center Joint	Side Joint
F221125	25	14/20	14/20
F221150	50	14/20	14/20
F221100	100	14/20	14/20
F221250	250	14/20	14/20
F224250	250	24/40	24/40
F221500	500	14/20	14/20
F224500	500	24/40	24/40
F222500	500	29/42	24/40
F224000	1000	24/40	24/40



FLASK, ROUND BOTTOM, 3-NECK BOTTOM OUTLET

Lower outlet is a 4mm straight bore Teflon® stopcock.

Item#	Capacity (mL)	Center Joint	Side Joint
F424450	500	24/40	24/40
F42441L	1000	24/40	24/40
F42442L	2000	24/40	24/40
F42542L	2000	45/50	24/40

Accessory:

S181530 Replacement 4mm Teflon® Plug Only



FLASK, ROUND BOTTOM 4-NECK, WITH THREADED SIDE ARM

Round bottom, four-neck flask with standard taper outer joints and a thermometer joints. Supplied complete with a compression cap and Viton® O-ring. For insertion of plan thermometers or bleed tubes having an O.D. between 5.0-7.0 mm.



Item#	Capacity (mL)	Center Joint	Side Joints
F714500	500	24/40	24/40
F71241L	1000	24/40	24/40
F71842L	2000	29/42	24/40
F71542L	2000	45/50	24/40

Accessories:

- RC009 Nylon® caps
- R107 Replacement Viton® O-rings, Size 107

* All sized including 2L flasks are hand-blown from tubing to ensure heavy and uniform wall.

FLASK, ROUND BOTTOM, 4-NECK

With identical vertical side joints.



Item#	Capacity (mL)	Center Joint	Side Joints
F214250	250	24/40	24/40
F214500	500	24/40	24/40
F212500	500	29/42	24/40
F218500	500	29/42	29/42
F214000	1000	24/40	24/40
F21841L	1000	29/42	24/40
F21842L	2000	29/42	24/40
F21342L	2000	34/45	24/40

*All sizes including 2L flasks are hand-blown from tubing to ensure heavy and uniform wall.



FLASK, ERLLENMEYER

With joint. Stopper is not supplied.

Item#	Joint	Capacity(mL)
F661405	14/20	5
F661410	14/20	10
F661425	14/20	25
F661450	14/20	50
F661950	19/22	50
F662450	24/40	50
F662950	29/42	50
F661125	14/20	125
F669125	19/22	125
F664125	24/40	125
F664250	24/40	250
F669250	29/42	250
F664500	24/40	500
F669500	29/42	500
F664000	24/40	1000
F668000	29/42	1000



*All sizes including 1L flasks are hand-blown from tubing to ensure heavy and uniform wall.

FLASK, FILTERING, WITH JOINT

Heavy wall design made from tubing to ensure excellent quality with 10 mm hose connection

Item#	Capacity (mL)	Joint
F724250	250	24/40
F724500	500	24/40
F724000	1000	24/40



TUBE, STORAGE, HIGH VACUUM VALVE

Supplied with high vacuum valve with PTFE O-ring at tip and PTFE wiper (“umbrella”) to protect Viton[®] O-ring on shaft.



Item#	Capacity (mL)	Valve Size	Tube O.D.× Length (mm)
F580025	25	0-4mm	26×110
F580825	25	0-8mm	26×110
F580050	50	0-4mm	28×120
F580850	50	0-8mm	28×120
F580100	100	0-4mm	40×165
F588100	100	0-8mm	40×165
F588250	250	0-8mm	60×185

Accessories:

S600004	Replacement 0-4mm high vacuum plug and control knob. (PTFE O-ring at tip)
S600008	Replacement 0-8mm high vacuum plug and control knob. (PTFE O-ring at tip)
R010	Viton [®] O-ring for 0-4mm high vacuum plug shaft
R110	Viton [®] O-ring for 0-8mm high vacuum plug shaft



FLASK, MODIFID SCHLENKN TUBE

Choice of either 2mm glass stopcock, 2mm Teflon® stopcock or 0-4mm high vacuum valve.

Item#	Capacity(mL)	Joint	Stopcock Type
F901410	10	14/20	Teflon®
F901425	25	14/20	Teflon®
F901450	50	14/20	Teflon®
F901950	50	19/22	Teflon®
F902450	50	24/40	Teflon®
F901100	100	14/20	Teflon®
F909100	100	19/22	Teflon®
F904100	100	24/40	Teflon®
F901200	200	14/20	Teflon®
F909200	200	19/22	Teflon®
F904200	200	24/40	Teflon®
F904500	500	24/40	Teflon®
F904000	1000	24/40	Teflon®
F901410G	10	14/20	Glass
F901425G	25	14/20	Glass
F901450G	50	14/20	Glass
F901950G	50	19/22	Glass
F902450G	50	24/40	Glass
F901100G	100	14/20	Glass
F909100G	100	19/22	Glass
F904100G	100	24/40	Glass
F901200G	200	14/20	Glass
F904200G	200	24/40	Glass
F904500G	500	24/40	Glass
F904000G	1000	24/40	Glass
F901425H	25	14/20	HV Valve
F901450H	50	14/20	HV Valve
F901950H	50	19/22	HV Valve
F902450H	50	24/40	HV Valve
F901100H	100	14/20	HV Valve
F909100H	100	19/22	HV Valve
F904100H	100	24/40	HV Valve
F901200H	200	14/20	HV Valve
F909200H	200	19/22	HV Valve
F904200H	200	24/40	HV Valve
F904500H	500	24/40	HV Valve
F904000H	1000	24/40	HV Valve

Accessories:

- S181125 Replacement 2mm Teflon® Plug Only
- S461230 Replacement 2mm Glass Plug Only
- S691230 Replacement S.S. Retention for 2mm Glass
- S600004 0-4mm high vacuum plug and control knob.
(PTFE O-ring at tip)
- R010 Vilton® O-ring for 0-4mm high vacuum plug shaft



TUBE, STORAGE WITH OUTER JOINT

Supplied with high vacuum valve with PTFE O-ring at tip.



Item#	Capacity (ml)	Joint	Valve Size	Tube O.D.×Length (mm)
F761425	25	14/20	0-4mm	26×110
F761450	50	14/20	0-4mm	28×120
F762450	50	24/40	0-4mm	28×120
F761100	100	14/20	0-4mm	40×165
F764100	100	24/40	0-4mm	40×165
F761108	100	14/20	0-8mm	40×165
F764108	100	24/40	0-8mm	40×165
F764258	250	24/40	0-8mm	60×185
F764358	350	24/40	0-8mm	70×200

Accessories

S600004	Replacement 0-4mm high vacuum plug and control knob. (PTFE O-ring at tip)
S600008	Replacement 0-8mm high vacuum plug and control knob. (PTFE O-ring at tip)
R010	Viton® O-ring for 0-4mm high vacuum plug shaft
R110	Viton® O-ring for 0-8mm high vacuum plug shaft

FLASK, STORAGE WITH OUTER JOINT

Supplied with high vacuum valve with PTFE O-ring at tip.



Item#	Capacity (mL)	Joint	Valve Size
F461010	10	14/20	0-4mm
F461025	25	14/20	0-4mm
F461050	50	14/20	0-4mm
F461100	100	14/20	0-4mm
F464100	100	24/40	0-4mm
F461250	250	14/20	0-4mm
F464250	250	24/40	0-4mm
F461500	500	14/20	0-4mm
F464500	500	24/40	0-4mm
F464508	500	24/40	0-8mm
F464008	1000	24/40	0-8mm

Accessories:

S600004	Replacement 0-4mm high vacuum plug and control knob. (PTFE O-ring at tip)
S600008	Replacement 0-8mm high vacuum plug and control knob. (PTFE O-ring at tip)



FLASK, SOLVENT TRANSFER/STORAGE

Item#	Capacity (mL)	Joint	Valve Size
F484250	250	24/40	0-4mm
F484258	250	24/40	0-8mm
F481500	500	14/20	0-4mm
F484500	500	24/40	0-4mm
F484508	500	24/40	0-8mm
F484000	1000	24/40	0-4mm
F484008	1000	24/40	0-8mm

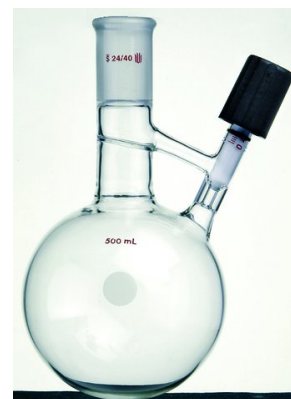

Accessories:

- S600004 Replacement 0-4mm high vacuum plug and control knob. (PTFE O-ring at tip)
- S600008 Replacement 0-8mm high vacuum plug and control knob. (PTFE O-ring at tip)
- R010 Viton® O-ring for 0-4mm high vacuum plug shaft
- R110 Viton® O-ring for 0-8mm high vacuum plug shaft

FLASK, HIGH VACUUM VALVE

Supplied with high vacuum valve with PTFE O-ring at tip and PTFE wiper(“umbrella”) to protect Viton® O-ring on shaft..

Item#	Capacity(mL)	Valve Size
F490010	10	0-4mm
F490050	50	0-4mm
F490100	100	0-4mm
F490250	250	0-4mm
F490258	250	0-8mm
F490500	500	0-4mm
F49081L	1000	0-8mm



Accessories:

- S600004 0-4mm high vacuum plug and control knob. (PTFE O-ring at tip)
- S600008 0-8mm high vacuum plug and control knob. (PTFE O-ring at tip)
- R010 Viton® O-ring for 0-4mm high vacuum plug shaft
- R110 Viton® O-ring for 0-8mm high vacuum plug shaft

FLASK, REACTION, HIGH VACUUM VALVE

Supplied with high vacuum valve with PTFE O-ring at tip and PTFE wiper to protect Viton® O-ring on shaft.



Item#	Capacity (mL)	Joint	Valve Size
F541050	50	14/20	0-4mm
F541950	50	19/22	0-4mm
F541100	100	14/20	0-4mm
F549100	100	19/22	0-4mm
F544100	100	24/40	0-4mm
F541250	250	14/20	0-4mm
F549250	250	19/22	0-4mm
F544250	250	24/40	0-4mm
F544500	500	24/40	0-4mm
F54241L	1000	24/40	0-4mm

Accessory:

S600004 0-4mm high vacuum plug and control knob.
(PTFE O-ring at tip)

FLASK, REACTION TUBE, HIGH VACUUM VALVE

Supplied with high vacuum valve with PTFE o-ring at tip and PTFE wiper (“umbrella”) to protect Viton® O-ring on shaft.



Item#	Capacity (mL)	Joint	Valve Size
F561025	25	14/20	0-4mm
F561050	50	14/20	0-4mm
F561100	100	14/20	0-4mm
F564100	100	24/40	0-4mm
F564250	250	24/40	0-4mm
F564350	350	24/40	0-4mm

Accessories:

S600004 0-4mm high vacuum plug and control knob.
(PTFE O-ring at tip)

R010 Viton® O-ring for 0-4mm high vacuum plug shaft



FLASK, REACTION, WITH GLASS STOPCOCK

With 2mm glass stopcock. With spring retention device for smooth turning purpose.

Item#	Capacity (mL)	Joint
F531050	50	14/20
F531100	100	14/20
F539100	100	19/22
F534100	100	24/40
F531250	250	14/20
F534250	250	24/40
F534500	500	24/40



Accessories:

- S461230 Replacement 2mm Glass Plug Only
- S691230 Replacement S.S. Retention for 2mm Glass stopcock

REPLACEMENT STAINLESS STEEL RETENTION KIT

Item#	Plug Size(mm)
S691230	12/30
S691656	16.2/56
S691740	17/40

FLASK, REACTION, 2-NECK

With a 2mm glass stopcock having a constant pressure retention device.

Item#	Capacity (mL)	Joints
F161450	50	14/20
F161100	100	14/20
F169100	100	19/22
F164100	100	24/40
F164250	250	24/40
F164500	500	24/40



Accessories:

- S461230 Replacement 2mm Glass Plug Only
- S691230 Replacement S.S. Retention for 2mm Glass stopcock

CRUCIBLE, GOOCH, LOW FORM

Item#	Capacity (mL)	Frit O.D. (mm)	Porosity
F771520M	15	20	medium
F773030C	30	30	coarse
F773030M	30	30	medium



FLASK, REACTION TUBE

With an outer joint and 2mm glass stopcock having a constant pressure retention device.



Item#	Capacity (mL)	Joint
F891410	10	14/20
F891425	25	14/20
F891450	50	14/20
F891950	50	19/22
F892450	50	24/40
F891100	100	14/20
F894100	100	24/40
F894200	200	24/40
F894250	250	24/40

Accessories:

- S461230 Replacement 2mm Glass Plug Only
 S691230 Replacement S.S. Retention for 2mm Glass stopcock

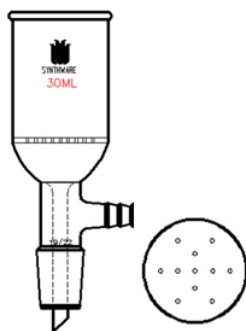
FILTER FUNNEL, BUCHNER, INNER JOINT, PERFORATED PLATE

Item#	Glass Disc Size (mm)	Capacity (mL)	Joint
F963014	32	30	14/20
F963024	32	30	24/40
F964014	42	60	14/20
F964024	42	60	24/40
F966024	60	150	24/40
F969024	90	600	24/40

FILTER FUNNEL, PERFORATED PLATE

Disc of O.D. is 24mm.

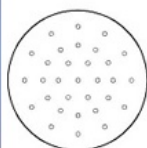

Item#	Joint	O.D. (mm)
F932450	24/40	50
F932475	24/40	75
F932490	24/40	90



FILTER FUNNEL

O.D. of Disc is 24mm.

Item#	Joint	O.D. (mm)	Porosity
F752450C	24/40	50	C
F752450M	24/40	50	M
F752475C	24/40	75	C
F752475M	24/40	75	M
F752490C	24/40	90	C
F752490M	24/40	90	M



FUNNEL, POWDER

Funnels have 60° side angle and a standard taper inner joint.

Item#	Top Dia. (mm)	Joint Size
F182450	50	24/40
F182475	75	24/40
F184100	100	24/40
F188100	100	29/42



FUNNEL, POWDER, FLATTENED SIDE

Funnels have 60° angled side with a standard taper inner joint.

Item#	Top Dia. (mm)	Joint Size
F191450	50	14/20
F191950	50	19/22
F192475	75	24/40
F192975	75	29/42
F194100	100	24/40
F198100	100	29/42

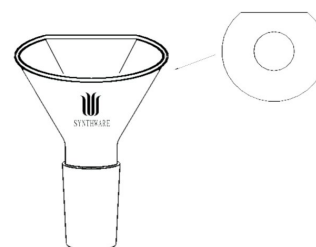

FUNNEL, POWDER, 60° OFFSET

For use with multi-neck flasks.

Item#	Joint	Approx. Diameter at Top (mm)
F392475	24/40	75
F394100	24/40	100



FUNNEL, SOLVENT ADDITION

Design of funnel permits addition of solvents to flash chromatography columns without disturbing the silica-gel/packing layer. Lower end of the funnel is closed and the stem has a series of small holes through which the solvent drains. Top of the funnel is 90mm in diameter with the stem size as listed.

Item#	Stem O.D. × length (mm)
F291275	12×75 *
F291210	12×100 *
F291975	19×75 *
F291910	19×100 *
F292810	28×100 **
F292812	28×125 **

* Fit column with 24/40 joint or 35/20 joint.

** Fit column with large joint like 45/50 standard or 50/30 spherical joint.

FILTER FUNNEL, BUCHNER, INNER JOINT

Not recommended for filtration where pressure would exceed 15psi.



Item#	Capacity (mL)	Joint	Frit O.D. (mm)	Porosity
F362014C	15	14/20	20	C
F362014M	15	14/20	20	M
F362019C	15	19/22	20	C
F362019M	15	19/22	20	M
F362024C	15	24/40	20	C
F362024M	15	24/40	20	M
F363014C	30	14/20	30	C
F363014M	30	14/20	30	M
F363019C	30	19/22	30	C
F363019M	30	19/22	30	M
F363024C	30	24/40	30	C
F363024M	30	24/40	30	M
F364014C	60	14/20	40	C
F364014M	60	14/20	40	M
F364019C	60	19/22	40	C
F364019M	60	19/22	40	M
F364024C	60	24/40	40	C
F364024M	60	24/40	40	M
F366024C	150	24/40	60	C
F366024M	150	24/40	60	M
F366029C	150	29/42	60	C
F366029M	150	29/42	60	M
F368024C	350	24/40	80	C
F368024M	350	24/40	80	M
F369024C	600	24/40	90	C
F369024M	600	24/40	90	M



FILTER FUNNEL, BUCHNER

With sealed-in glass disc of the listed porosity. Not recommended for filtration where pressure would exceed 15psi. XC-extra coarse, C-Coarse, M-Medium, F-Fine porosity.

Item#	Capacity (mL)	Disc O.D. (mm)	Porosity
F601002C	2	10	C
F601002M	2	10	M
F601002F	2	10	F
F602015C	15	20	C
F602015X	15	20	XC
F602015M	15	20	M
F602015F	15	20	F
F603030X	30	30	XC
F603030C	30	30	C
F603030M	30	30	M
F603030F	30	30	F
F604060X	60	40	XC
F604060C	60	40	C
F604060M	60	40	M
F604060F	60	40	F
F606150X	150	60	XC
F606150C	150	60	C
F606150M	150	60	M
F606150F	150	60	F
F608350X	350	80	XC
F608350C	350	80	C
F608350M	350	80	M
F608350F	350	80	F
F609600C	600	90	C
F609600M	600	90	M
F609600F	600	90	F



FUNNEL, FILTER, BUCHNER, PERFORATED PLATE

With sealed-in perforated glass disc to support filter media. Pressure may be used but should not exceed 15 psi. This design solve the contamination problem with fritted disc and also the blindness problem with ceramic Buchner funnel.

Item#	Glass Disc Size (mm)	Capacity (mL)
F804260	42	60
F806150	60	150
F808350	80	350
F809600	90	600

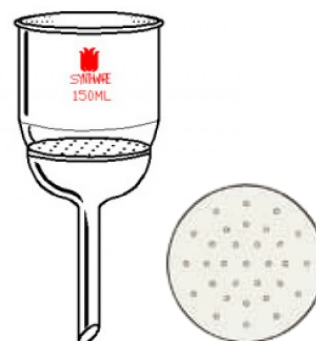



GAS DISPERSION TUBE, FRITTED

Stem is 8mm O.D ×150mm length, XC stands for extra coarse porosity.

Item#	Disc. Dia (mm)	Porosity
F260810X	10	XC
F260810C	10	C
F260810M	10	M



GAS DISPERSION TUBE, FRITTED, 15°ANGLE

The 15° angle permits tube to be inserted into vessels where a large opening is not available. Stem is 8mm O.D.×150mm length, XC stands for extra coarse porosity.

Item#	Disc. Dia (mm)	Opening Required (mm)	Porosity
F271018M	10	18	M
F272025C	20	25	C
F272025M	20	25	M
F273035X	30	35	XC
F274045M	40	45	M

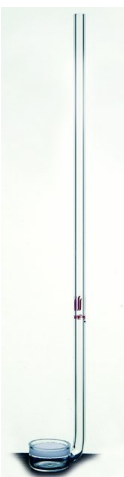

GAS DISPERSION TUBE, FRITTED, 90°ANGLE

The 90° angle permits bubbles to be spread over a large area. Stem is 8mm O.D.×150 Length; XC stands for extra coarse porosity

Item#	Disc. Dia. (mm)	Opening Required (mm)	Porosity
F282035M	20	35	M
F283045C	30	45	C
F284060X	40	60	XC
F284060C	40	60	C
F284060M	40	60	M



FILTER, TUBE, FRITTED DISC

Available with a choice of coarse or medium porosity fritted discs.

Item#	Joints	Approximate Frit O.D. (mm)	Porosity
F701420C	14/20	20	C
F701420M	14/20	20	M
F701430C	14/20	30	C
F701430M	14/20	30	M
F702440C	24/40	36	C
F702440M	24/40	36	M



FILTER, TUBE, FRITTED DISC

With two 2mm glass stopcocks having constant pressure retention devices.

Item#	Joints	Approximate Frit O.D. (mm)	Porosity
F351430C	14/20	30	C
F351430M	14/20	30	M
F352440C	24/40	36	C
F352440M	24/40	36	M



Accessories:

- S461230 Replacement 2mm Glass Plug Only
- S691230 Replacement S.S. Retention for 2mm Glass stopcock

FUNNEL, ADDITION, HIGH VACUUM VALVE

Supplied with high vacuum valve with PTFE O-ring at tip and PTFE wiper to protect Viton® O-ring on shaft.

Item#	Joints	Capacity(mL)
F551060	14/20	100
F554200	24/40	250

Accessories:

- S600004 0-4mm high vacuum plug and control knob.(PTFE O-ring at tip)
- R010 Viton® O-ring for 0-4mm high Vacuum plug shaft



PEPTIDE SYNTHESIS VESSEL, SOLID PHASE

With a fritted disc of coarse or medium porosity to support resin. Top of the vessel has GL thread and a Teflon[®] lined screw cap. Teflon[®] stopcock has a 2mm bore with the arm being 8mm O.D.



Item#	Capacity (mL)	Fritted Disc O.D. (mm)	GL thread size
P120010C	10	15	14
P120010M	10	15	14
P120025C	25	20	25
P120025M	25	20	25
P120050C	50	25	25
P120050M	50	25	25

Accessories:

S181125	Replacement 2mm Teflon [®] Plug Only
GL14	Nylon [®] cap 14mm
GL25	Nylon [®] cap 25mm
R14	PTFE septum 14mm
R25	PTFE septum 25mm

PEPTIDE SYNTHESIS VESSEL, SOLID PHASE
T-BORE TEFLON[®] STOPCOCK

With a fritted disc of coarse or medium porosity to support resin. Top of the vessel has GL thread and a Teflon[®] lined screw cap. Teflon[®] stopcock has a 2mm bore with the arm being 8mm O.D.



Item#	Capacity (mL)	Fritted Disc O.D. (mm)	GL thread size
P130010C	10	15	14
P130050C	50	25	25
P130050M	50	25	25
P130100C	100	40	25
P130100M	100	40	25

Accessories:

S201530	2mm Teflon [®] T-bore Stopcock Plug
GL14	Nylon [®] cap 14mm
GL25	Nylon [®] cap 25mm
R14	PTFE septum 14mm
R25	PTFE septum 25mm

PEPTIDE SYNTHESIS VESSEL, SOLID PHASE, T-BORE, VACUUM

A connection of 8mm O.D. is sealed on the inner joint for connection to an inner gas. With a fritted disc of coarse or medium porosity to support resin. Top of the vessel has GL thread and a Teflon[®] lined screw cap. Teflon[®] stopcock has a 2mm bore with the arm being 8mm O.D.

Item#	Capacity (mL)	Fritted Disc O.D. (mm)	GL thread size
P140010M	10	15	14
P140025M	25	20	25
P140050M	50	25	25
P140100M	100	40	25

Accessories:

S201530	2mm Teflon [®] T-bore Stopcock Plug
GL14	Nylon [®] cap 14mm
GL25	Nylon [®] cap 25mm
R14	PTFE septum 14mm
R25	PTFE septum 25mm

NYLON[®] CAP WITH PROTECTED SEAL

Replacement caps for use with Solid Phase Reaction Vessels, with PTFE protected Silicone Septum.

Item#	Size (mm)	Material
GL14	14	Nylon [®]
GL25	25	Nylon [®]
GL32	32	Nylon [®]

SEPTUM, TEFLON[®]

Item#	Size(mm)	Material
R14	14	PTFE
R25	25	PTFE
R32	32	PTFE



VESSEL, WITH LOWER JOINT AND T-BORE PTFE PLUG

Solid phase peptide synthesis vessels feature 2mm PTFE stopcocks and fritted glass supports for resin beads during operation. The 24/40 inner drip joint can be assembled with other standard glassware. The vessel has a 8mm hose connection for vacuum and the stopcock has an 8mm O.D. sidearm for inert gas introduction. Vessels are supplied with PTFE-faced silicone lined Nylon® cap.



Item#	Capacity (mL)	Fritted Disc O.D. (mm)	Porosity	GL thread Size
P150025M	25	25	M	25
P150050C	50	30	C	25
P150050M	50	30	M	25
P150100M	100	45	M	25
P150250M	250	57	M	32
P150500M	500	80	M	32

Accessories:

S201530	2mm Teflon® T-bore Stopcock Plug
GL14	Nylon® cap 14mm
GL25	Nylon® cap 25mm
GL32	Nylon® cap 32mm
R14	PTFE septum 14mm
R25	PTFE septum 25mm
R32	PTFE septum 32mm



REACTION VESSEL, PHOTOCHEMICAL, INTERNAL THREAD

Reaction Vessel constructed of borosilicate glass to accommodate immersion well. With #50 internal thread at top which accepts a RC50 bushing and Viton® O-ring to form a compression seal with the immersion well, one 14/20 joint for sparger tube, one 24/40 vertical joint for condenser and one #7 internal thread side arm for thermometer. Complete with quartz immersion well, caps and O-rings.



Item#	Capacity(mL)
V150500	500

Accessories:

- RC50 Bushing,#50,Nylon® w/o O-ring, Only
- R225 O-ring for #50 internal thread
- RC7 Nylon® cap for #7 internal thread
- R008 O-ring for #7 internal thread

IMMERSION WELL, PHOTOCHEMICAL, QUARTZ, WITHOUT JOINT

Double-walled quartz immersion well for use with V150500 reactor and lamp. A small diameter inner tube extends down the annular space to insure flow of coolant from bottom of well upward to outlet. Well is used with RC50 Nylon® Bushing with Viton® O-ring to form a compression type seal with threaded vessels. Well offers a greaseless connection and can be adjusted to desired height .The lack of the ground joint means easier dismantling since there is no freezing.



Item#	Total Length
V190390	390mm

PRESSURE VESSEL, HEAVY WALL*

Heavy wall cylindrical vessels have an internal thread for use with a 15mm Teflon[®] bushing as a pressure seal. This unique design allows hand tightening and loosening for easy access into the vessel. The O-ring is positioned on the bushing above the thread for improved sealing. The vessels are useful for pressure reactions and applications such as polymerization and analysis of halogens by thermal decomposition in the presence of lime. Complete apparatus is supplied with vessel, Teflon[®] bushing and Viton[®] O-ring.



Item#	Capacity (mL)	O.D.×Overall (mm)	GL thread size	Supplied
P160001	15	26×109	15	complete
P160002	35	26×164	15	complete
P160003	38	26×174	15	complete
P160004	48	46×109	15	complete
P160005	100	46×149	15	complete
P160006	120	46×169	15	complete

***Important Warnings for Pressurized Glassware:** Due to varying conditions, we cannot guarantee glass vessels from breakage under pressure. Always work behind a safety shield.

PRESSURE VESSEL, HEAVY WALL*

Heavy wall round bottom vessels have an internal thread for use with a 15mm Teflon[®] bushing as a pressure seal. This unique design allows hand tightening and loosening for easy access into the vessel. The O-ring is positioned on the bushing above the thread for improved sealing. The vessels are useful for pressure reactions and applications such as polymerization and analysis of halogens by thermal decomposition in the presence of lime. Complete apparatus is supplied with vessel, Teflon[®] bushing and Viton[®] O-ring.



Item#	Capacity (mL)	O.D.×Overall (mm)	GL thread size	Supplied
P170001	75	46×129	15	complete
P170002	75	50×137	25	complete
P170003	150	60×139	15	complete
P170004	150	60×147	25	complete
P170005	350	80×154	15	complete
P170006	350	80×162	25	complete

***Important Warnings for Pressurized Glassware:** Due to varying conditions, we cannot guarantee glass vessels from breakage under pressure. Always work behind a safety shield.

**FUNNEL, FILTER, FRITTED DISC**

With two 2mm glass stopcocks

Item#	Joints	Frit O.D. (mm)	Porosity	Capacity (mL)
F973014C	14/20	30	Coarse	60
F973014M	14/20	30	Medium	60
F973024C	24/40	30	Coarse	60
F973024M	24/40	30	Medium	60

Accessories:

- S461230 Replacement 2mm Glass Plug only
S691230 Replacement S.S. Retention for 2mm Glass stopcock

**FUNNEL, FILTER, FRITTED DISC**

With a 0-4mm high vacuum valve and a 2mm glass stopcock having constant pressure retention device.

Item#	Joints	Frit O.D. (mm)	Porosity	Capacity (mL)
F371460M	14/20	30	medium	60
F374200C	24/40	40	coarse	200
F374200M	24/40	40	medium	200

Accessories:

- S461230 Replacement 2mm Glass Plug only
S691230 Replacement S.S. Retention for 2mm Glass stopcock
S600004 0-4mm high vacuum plug and control knob(PTFE O-ring at tip and PTEF wiper to protect Viton® O-ring on shaft
R010 Viton® O-ring for 0-4mm high vacuum plug shaft

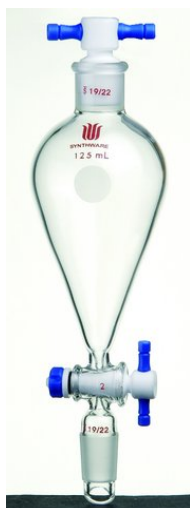

FUNNEL, SEPARATORY

 With 2mm Teflon[®] stopcock. Supplied with a glass stopper or PTFE stopper.

Item#	Capacity (mL)	Joints	PTFE stopcock (mm)	Stopper
F451010	10	14/20	2	PTFE
F451010A	10	14/20	2	GLASS
F451025	25	14/20	2	PTFE
F451025A	25	14/20	2	GLASS
F459025	25	19/22	2	PTFE
F451050	50	14/20	2	PTFE
F451050A	50	14/20	2	GLASS
F459050	50	19/22	2	PTFE
F451100	100	14/20	2	PTFE
F451100A	100	14/20	2	GLASS
F459100	100	19/22	2	PTFE
F459100A	100	19/22	2	GLASS
F451125	125	14/20	2	PTFE
F451125A	125	14/20	2	GLASS
F459125	125	19/22	2	PTFE
F459125A	125	19/22	2	GLASS
F454125	125	24/40	2	PTFE
F454125A	125	24/40	2	GLASS
F451250	250	14/20	4	PTFE
F451250A	250	14/20	4	GLASS
F459250	250	19/22	4	PTFE
F459250A	250	19/22	4	GLASS
F454250	250	24/40	4	PTFE
F454250A	250	24/40	4	GLASS

Accessories:

S181125	Replacement 2mm Teflon [®] Plug Only
S181530	Replacement 4mm Teflon [®] Plug Only
S401420	14/20 Hollow glass stopper , Penny-head
S401922	19/22 Hollow glass stopper , Penny-head
S402440	24/40 Hollow glass stopper , Penny-head
S111420	14/20 Teflon [®] stopper
S111922	19/22 Teflon [®] stopper
S112440	24/40 Teflon [®] stopper



FUNNEL, SEPARATORY, TEFLON® STOPCOCK

Supplied with a Glass or Teflon® stopper

Item#	Capacity (mL)	Joint	PTFE Stopcock (mm)	Stopper
F471010	10	14/20	2	PTFE
F471025	25	14/20	2	PTFE
F479025	25	19/22	2	PTFE
F471330	30	NO.13	2	PTFE
F471050	50	14/20	2	PTFE
F479050	50	19/22	2	PTFE
F471660	60	NO.16	2	PTFE
F471100	100	14/20	2	PTFE
F479100	100	19/22	2	PTFE
F471125	125	14/20	2	PTFE
F479125	125	19/22	2	PTFE
F474125	125	24/40	2	PTFE
F472125	125	No.22	2	PTFE
F479250	250	19/22	4	PTFE
F474250	250	24/40	4	PTFE
F472925	250	29/42	4	PTFE
F472250	250	No.22	4	PTFE
F472950	500	29/42	4	PTFE
F477500	500	No.27	4	PTFE
F474000	1000	24/40	4	PTFE
F477000	1000	No.27	4	PTFE
F471010A	10	14/20	2	GLASS
F479010A	10	19/20	2	GLASS
F471025A	25	14/20	2	GLASS
F479025A	25	19/22	2	GLASS
F471330A	30	NO.13	2	GLASS
F471050A	50	14/20	2	GLASS
F479050A	50	19/22	2	GLASS
F471660A	60	NO.16	2	GLASS
F471100A	100	14/20	2	GLASS
F479100A	100	19/22	2	GLASS
F471125A	125	14/20	2	GLASS
F479125A	125	19/22	2	GLASS
F474125A	125	24/40	2	GLASS
F472125A	125	No.22	2	GLASS
F479250A	250	19/22	4	GLASS
F474250A	250	24/40	4	GLASS
F472925A	250	29/42	4	GLASS
F472250A	250	No.22	4	GLASS
F472950A	500	29/42	4	GLASS
F477500A	500	No.27	4	GLASS
F474000A	1000	24/40	4	GLASS
F477000A	1000	No.27	4	GLASS



Accessories:

- S181125 Replacement 2mm Teflon® Plug Only
- S181530 Replacement 4mm Teflon® Plug Only
- S401420 14/20 Hollow Glass Stopper,Penny-head
- S401922 19/22 Hollow Glass Stopper,Penny-head
- S402440 24/40 Hollow Glass Stopper,Penny-head
- S402942 29/42 Hollow Glass Stopper,Penny-head
- S111420 14/20 Teflon® Stopper
- S111922 19/22 Teflon® Stopper
- S112440 24/40 Teflon® Stopper
- S112942 29/42 Teflon® Stopper
- S120013 # 13 Teflon® Stopper
- S120016 # 16 Teflon® Stopper
- S120022 # 22 Teflon® Stopper
- S120027 # 27 Teflon® Stopper
- S280013 # 13 Glass Stopper , Penny-head
- S280016 # 16 Glass Stopper , Penny-head
- S280022 # 22 Glass Stopper , Penny-head
- S280027 # 27 Glass Stopper , Penny-head



FUNNEL, SEPARATORY, SQUIBB, GLASS STOPCOCK

Supplied complete with a flask length glass stopper of the listed size

Item#	Capacity (mL)	Stopper size	Stopcock bore (mm)	Stopper
F780030	30	#13	2	GLASS
F780060	60	#16	2	GLASS
F780125	125	#22	2	GLASS
F780250	250	#22	4	GLASS
F780500	500	#27	4	GLASS
F787000	1000	#27	4	GLASS

Accessories:

- S461230 Replacement 2mm Glass Plug Only
- S461740 Replacement 4mm Glass Plug Only
- S691230 Replacement S.S. Retention for 2mm Glass stopcock
- S691740 Replacement S.S. Retention for 2mm Glass stopcock
- S280013 # 13 Glass Stopper , Penny-head
- S280016 # 16 Glass Stopper , Penny-head
- S280022 # 22 Glass Stopper , Penny-head
- S280027 # 27 Glass Stopper , Penny-head



FUNNEL SEPARATORY SURE-GRIP

Globe shaped separatory funnel with a long stopper neck and straight section between the funnel body and stopcock, which provides a secure grip while shaking and also aids in clamping. Available with Teflon® stopcocks. Supplied complete with one listed size Teflon® or glass stopper.

Item#	Capacity (mL)	Stopper size	PTFE Stopcock Bore (mm)	Stopper
F687500A	500	27	4	Glass
F687000A	1000	27	4	Glass
F687000	1000	27	4	PTFE
F68272LA	2000	27	4	Glass
F68272L	2000	27	4	PTFE

Accessories:

- S181530 Replacement 4mm Teflon® Plug Only
- S280027 # 27 Glass Stopper , Penny-head
- S120027 # 27 Teflon® Stopper

**FUNNEL, PRESSURE EQUALIZING**With 1:5 Teflon[®] stopcock

Item#	Capacity(mL)	Joints	Stopcock Bore(mm)
F621410	10	14/20	2
F621425	25	14/20	2
F622425	25	24/40	2
F621460	60	14/20	2
F621960	60	19/22	2
F622460	60	24/40	2
F621125	125	14/20	2
F629125	125	19/22	2
F624125	125	24/40	2
F629250	250	19/22	2
F624250	250	24/40	2
F624500	500	24/40	4
F62241L	1000	24/40	4

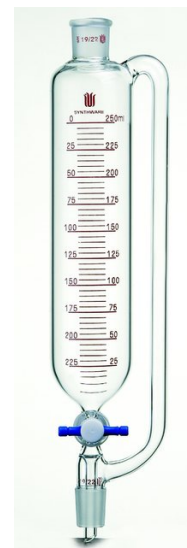
Accessories:S181125 Replacement 2mm Teflon[®] Plug OnlyS181530 Replacement 4mm Teflon[®] Plug Only**FUNNEL, PRESSURE EQUALIZING, TEFLON[®] METERING STOPCOCK**

With Teflon[®] adjustable bore metering plug. Turning the adjustment knob allows flow rate to be controlled from full flow to drop wise. The metering plug completely solves the problems of sudden overflow or non-flow during addition of reagents.

Item#	Capacity (mL)	Joints	PTFE Stopcock Bore(mm)
F611410	10	14/20	2
F611425	25	14/20	2
F611460	60	14/20	2
F611960	60	19/22	2
F612460	60	24/40	2
F614125	125	24/40	2
F614250	250	24/40	2
F614500	500	24/40	4

Accessories:S191125 Replacement 2mm Teflon[®] Metering OnlyS191530 Replacement 4mm Teflon[®] Metering Only

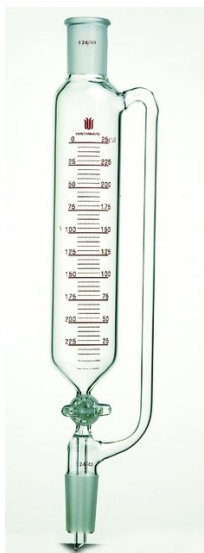

FUNNEL, PRESSURE EQUALIZING, GLASS STOPCOCK

With glass stopcock, graduated.

Item#	Capacity (mL)	Joints	Stopcock Bore(mm)
F621410G	10	14/20	2
F621425G	25	14/20	2
F621460G	60	14/20	2
F622460G	60	24/40	2
F621125G	125	14/20	2
F624250G	250	24/40	2

Accessories:

S461230 Replacement 2mm Glass Plug Only

S691230 Replacement S.S. Retention for 2mm Glass Stopcock

**FUNNEL, PRESSURE EQUALIZING, TEFLON® STOPCOCK**

With straight bore Teflon® stopcock in pressure equalizing line, graduated

Item#	capacity (mL)	Joints	Stopcock Bore(mm)
F671425	25	14/20	2
F672460	60	24/40	2
F674125	125	24/40	2
F674250	250	24/40	2
F674500	500	24/40	4
F67241L	1000	24/40	4

Accessories:

S181125	Replacement 2mm Teflon® Plug Only
S181530	Replacement 4mm Teflon® Plug Only

**FUNNEL, PRESSURE EQUALIZING, HIGH VACUUM VALVE**

With Teflon® extended tip valve for semi-needle valve adjustment.

Item#	Capacity (mL)	Joints	Valve Orifice (mm)
F641425	25	14/20	0-4
F641460	60	14/20	0-4
F641960	60	19/22	0-4
F642460	60	24/40	0-4
F641125	125	14/20	0-4
F649125	125	19/22	0-4
F644125	125	24/40	0-4
F644250	250	24/40	0-4

Accessories:

S660004	0-4mm high vacuum metering plug and control knob.(PTFE O-ring at tip and PTFE wiper to protect Viton® O-ring on shaft.)
R010	Viton® O-ring for 0-4mm high vacuum plug shaft



MANIFOLD, VACUUM/INERT GAS, DOUBLE

General purpose double bank manifold for use with vacuum and inert gas. Supplied with 0-4mm high vacuum valves for grease-free operation. Both banks are made from 22mm medium wall tubing and have all banks open. Ports are spaced 100mm center to center and have an O.D. of 10mm.



Item#	Number of ports	Overall width (mm)	Valve orifice (mm)
M111004	4	450	0-4
M111005	5	550	0-4

Accessories:

- S540004 0-4mm high vacuum plug and control knob. (With Viton® O-ring at tip)
- R010 Viton® O-ring for 0-4mm high vacuum plug shaft
- R007 Viton® O-ring for 0-4mm high vacuum valve tip O-ring

MANIFOLD, VACUUM/INERT GAS, DOUBLE

Same to the manifold above except with front-left and rear-right 10mm hose connections.



Item#	Number of Ports	Overall Width (mm)	Valve Orifice (mm)
M171005	5	550	0-4

Accessories:

- S540004 0-4mm high vacuum plug and control knob. (With Viton® O-ring at tip)
- R010 Viton® O-ring for 0-4mm high vacuum plug shaft
- R007 Viton® O-ring for 0-4mm high vacuum valve tip O-ring

MANIFOLD, VACUUM/INERT GAS, DOUBLE

Same to the manifold above except with front-left and rear-right 10mm hose connections.

Item#	Number of Ports	Overall Width (mm)	Valve Orifice (mm)
M101003	3	350	0-4
M101004	4	450	0-4
M101005	5	550	0-4



Accessories:

- S540004 0-4mm high vacuum plug and control knob. (With Viton® O-ring at tip)
- R010 Viton® O-ring for 0-4mm high vacuum plug shaft
- R007 Viton® O-ring for 0-4mm high vacuum valve tip O-ring

MANIFOLD, VACUUM/INERT GAS, DOUBLE

Same to the manifold above except with front- right and rear- left 10mm hose connections.

Item#	Number of Ports	Overall Width(mm)	Valve Orifice (mm)
M141004	4	450	0-4mm
M141005	5	550	0-4mm



Accessories:

- S540004 0-4mm high vacuum plug and control knob. (With Viton® O-ring at tip)
- R010 Viton® O-ring for 0-4mm high vacuum plug shaft
- R007 Viton® O-ring for 0-4mm high vacuum valve tip O-ring

MANIFOLD, VACUUM/INERT GAS, DOUBLE

Same to the manifold above except with front-left-right and rear-right 10mm hose connections.

Item#	Number of Ports	Overall Width (mm)	Valve Orifice (mm)
M471004	4	450	0-4mm
M471005	5	550	0-4mm



Accessories:

- S540004 0-4mm high vacuum plug and control knob. (With Viton® O-ring at tip)
- R010 Viton® O-ring for 0-4mm high vacuum plug shaft
- R007 Viton® O-ring for 0-4mm high vacuum valve tip O-ring

MANIFOLD, VACUUM/INERT GAS, ALL GLASS

With 4mm double oblique, high vacuum hollow glass stopcocks precision ground with corresponding numbers on barrel and plug. Lower vacuum chambers on stopcock are evacuated with a separate hole in the plug in order to hold the plug in the stopcock barrels. Beams are 22mm O.D. with front-left-right and rear-left-right 10mm hose connections. Distance between stopcocks is 75mm center to center.



Item#	Number of Ports	Overall Width (mm)
M411003	3	300
M411004	4	375
M411005	5	450

MANIFOLD, VACUUM/INERT GAS, ALL GLASS

With 4mm double oblique, high vacuum hollow glass stopcocks precision ground with corresponding numbers on barrel and plug. Lower vacuum chambers on stopcock are evacuated with a separate hole in the plug in order to hold the plug in the stopcock barrels. Beams are 22mm O.D. with front-left and rear-right 10mm hose connections. Distance between stopcocks is 75mm center to center.



Item#	Number of Ports	Overall Width (mm)
M181003	3	300
M181004	4	375
M181005	5	450

MANIFOLD, VACUUM/INERT GAS, ALL GLASS

With 4mm double oblique, high vacuum hollow glass stopcocks precision ground with corresponding numbers on barrel and plug. Lower vacuum chambers on stopcock are evacuated with a separate hole in the plug in order to hold the plug in the stopcock barrels. Beams are 22mm O.D. with front-right and rear-left 10mm hose connections. Distance between stopcocks is 75mm center to center.



Item#	Number of Ports	Overall Width (mm)
M401004	4	375
M401005	5	450

MANIFOLD, VACUUM/INERT GAS, ALL GLASS

With 4mm double oblique, high vacuum hollow glass stopcocks precision ground with corresponding numbers on barrel and plug. Lower vacuum chambers on stopcock are evacuated with a separate hole in the plug in order to hold the plug in the stopcock barrels. Beams are 22mm O.D. with front-left-right and rear-left 10mm hose connections. Distance between stopcocks is 75mm center to center.

Item#	Number of ports	Overall width (mm)
M421003	3	300
M421004	4	375
M421005	5	450



MANIFOLD, VACUUM/INERT GAS, ALL GLASS

With 4mm double oblique, high vacuum hollow glass stopcocks precision ground with corresponding numbers on barrel and plug. Lower vacuum chambers on stopcock are evacuated with a separate hole in the plug in order to hold the plug in the stopcock barrels. Beams are 22mm O.D. with front-left and rear-left-right 10mm hose connections. Distance between stopcocks is 75mm center to center.

Item#	Number of Ports	Overall Width (mm)
M431003	3	300
M431004	4	375
M431005	5	450



MANIFOLD, VACUUM/INERT GAS, ALL GLASS

With 4mm double oblique, high vacuum hollow glass stopcocks precision ground with corresponding numbers on barrel and plug. Lower vacuum chambers on stopcock are evacuated with a separate hole in the plug in order to hold the plug in the stopcock barrels. Beams are 22mm O.D. with front-left-right and rear-right 10mm hose connections. Distance between stopcocks is 75mm center to center.

Item#	Number of Ports	Overall Width (mm)
M441005	5	450



MANIFOLD, VACUUM/INERT GAS, ALL GLASS

With 4mm double oblique, high vacuum hollow glass stopcocks precision ground with corresponding numbers on barrel and plug. Lower vacuum chambers on stopcock are evacuated with a separate hole in the plug in order to hold the plug in the stopcock barrels. Beams are 22mm O.D. with front-right and rear-left-right 10mm hose connections. Distance between stopcocks is 75mm center to center.



Item#	Number of Ports	Overall Width (mm)
M451004	4	375
M451005	5	450

MANIFOLD, HIGH VACUUM SOLID GLASS STOPCOCKS

With 4mm double oblique, high vacuum solid glass stopcocks precision ground with corresponding numbers on barrel and plug. Solid glass stopcocks have constant pressure retention devices. Beams are 22mm O.D. with front-left-right and rear-left-right 10mm hose connections. Distance between stopcocks is 75mm center to center.



Item#	Number of Ports	Overall Width (mm)
M250003	3	300
M250004	4	375
M250005	5	450

Accessory:

S691656 Replacement stainless steel retention kit for 16.2/56 glass stopcock

MANIFOLD, HIGH VACUUM SOLID GLASS STOPCOCKS

With 4mm double oblique, high vacuum solid glass stopcocks precision ground with corresponding numbers on barrel and plug. Solid glass stopcocks have constant pressure retention devices. Beams are 22mm O.D. with front-left and rear-right 10mm hose connections. Distance between stopcocks is 75mm center to center.



Item#	Number of Ports	Overall Width (mm)
M230003	3	300
M230004	4	375
M230005	5	450

Accessory:

S691656 Replacement stainless steel retention kit for 16.2/56 glass stopcock



MANIFOLD, HIGH VACUUM SOLID GLASS STOPCOCKS

With 4mm double oblique, high vacuum solid glass stopcocks precision ground with corresponding numbers on barrel and plug. Solid glass stopcocks have constant pressure retention devices. Beams are 22mm O.D. with front-right and rear-left 10mm hose connections. Distance between stopcocks is 75mm center to center.

Item#	Number of Ports	Overall Width (mm)
M240004	4	375

Accessory:

S691656 Replacement stainless steel retention kit for 16.2/56 glass stopcock



MANIFOLD, HIGH VACUUM SOLID GLASS STOPCOCKS

With 4mm double oblique, high vacuum solid glass stopcocks precision ground with corresponding numbers on barrel and plug. Solid glass stopcocks have constant pressure retention devices. Beams are 22mm O.D. with front-left-right and rear-left 10mm hose connections. Distance between stopcocks is 75mm center to center.

Item#	Number of Ports	Overall Width (mm)
M260003	3	300
M260004	4	375
M260005	5	450

Accessory:

S691656 Replacement stainless steel retention kit for 16.2/56 glass stopcock



MANIFOLD, HIGH VACUUM SOLID GLASS STOPCOCKS

With 4mm double oblique, high vacuum solid glass stopcocks precision ground with corresponding numbers on barrel and plug. Solid glass stopcocks have constant pressure retention devices. Beams are 22mm O.D. with front-left and rear-left-right 10mm hose connections. Distance between stopcocks is 75mm center to center.

Item#	Number of Ports	Overall Width (mm)
M280004	4	375
M280005	5	450

Accessory:

S691656 Replacement stainless steel retention kit for 16.2/56 glass stopcock



MANIFOLD, HIGH VACUUM SOLID GLASS STOPCOCKS

With 4mm double oblique, high vacuum solid glass stopcocks precision ground with corresponding numbers on barrel and plug. Solid glass stopcocks have constant pressure retention devices. Beams are 22mm O.D. with front-left-right and rear-right 10mm hose connections. Distance between stopcocks is 75mm center to center.



Item#	Number of Ports	Overall Width (mm)
M290004	4	375
M290005	5	450

Accessory:

S691656 Replacement stainless steel retention kit for 16.2/56 glass stopcock

MANIFOLD, HIGH VACUUM SOLID GLASS STOPCOCKS

With 4mm double oblique, high vacuum solid glass stopcocks precision ground with corresponding numbers on barrel and plug. Solid glass stopcocks have constant pressure retention devices. Beams are 22mm O.D. with front-right and rear-left-right 10mm hose connections. Distance between stopcocks is 75mm center to center.



Item#	Number of Ports	Overall Width (mm)
M300005	5	450

Accessory:

S691656 Replacement stainless steel retention kit for 16.2/56 glass stopcock

VACCUM MANIFOLD, TEFLON® STOPCOCKS

General purpose manifold with 2mm or 4mm Teflon® stopcocks. Main tube is 22mm O.D. with serrated hose connection(10mm O.D.) at right side. Delivery ports have 10mm serrated hose connections. Distance between stopcocks is 75mm.



Item#	Number of Ports	Stopcock Bore (mm)
M190042	4	2
M190044	4	4
M190064	6	4

Accessories:

S181125 Replacement 2mm Teflon® Plug Only
 S181530 Replacement 4mm Teflon® Plug Only

VACUUM MANIFOLD, TEFLON® STOPCOCKS

General purpose manifold with 2mm or 4mm Teflon® stopcocks. Main tube is 22mm O.D. with serrated hose connection(10mm O.D.) at left side. Delivery ports have 10mm serrated hose connections. Distance between stopcocks is 75mm.

Item#	Number of Ports	Stopcock Bore (mm)
M500044	4	4
M500064	6	4

Accessories:

S181530 Replacement 4mm Teflon® Plug Only

VACUUM MANIFOLD, TEFLON® STOPCOCKS

General purpose manifold with 2mm or 4mm Teflon® stopcocks. Main tube is 22mm O.D. with serrated hose connection(10mm O.D.) at both ends. Delivery ports have 10mm serrated hose connections. Distance between stopcocks is 75mm.

Item#	Number of Ports	Stopcock Bore (mm)
M490042	4	2
M490044	4	4
M490062	6	2
M490064	6	4

Accessories:

S181125 Replacement 2mm Teflon® Plug Only

S181530 Replacement 4mm Teflon® Plug Only

VACUUM MANIFOLD, HIGH VACUUM VALVES

With a serrated hose connection(10mm O.D.) at right hand side. Main tube is 22mm O.D. and the distance between valves is 100mm center to center.

Item#	Number of Ports	Stopcock Bore(mm)	Overall Width(mm)
M202403	3	0-4	325
M202404	4	0-4	425
M202405	5	0-4	525

Accessories:

S540004 0-4mm high vacuum plug and control knob.
(With Viton® O-ring at tip)

R010 Viton® O-ring for 0-4mm high vacuum plug shaft

R007 Viton® O-ring for 0-4mm high vacuum valve tip

VACUUM MANIFOLD, HIGH VACUUM VALVES

With a serrated hose connection(10mm O.D.) at left hand side. Main tube is 22mm O.D. and the distance between valves is 100mm center to center.



Item#	Number of Ports	Stopcock Bore (mm)	Overall Width (mm)
M522403	3	0-4	325
M522404	4	0-4	425
M522405	5	0-4	525

Accessories:

- S540004 0-4mm high vacuum plug and control knob.
(With Viton® O-ring at tip)
- R010 Viton® O-ring for 0-4mm high vacuum plug shaft
- R007 Viton® O-ring for 0-4mm high vacuum valve tip

MANIFOLD, NITROGEN/ARGON LINE, TEFLON®

With 14/20 outer joint at the center to fit a rubber septum for keeping syringes under an inert environment cutting down on the number used. Main tube is 22mm O.D. with both ends connections(10mm). Delivery ports have 8mm hose connections.



Item#	Number of Ports	Stopcock Bore (mm)	Joint
M211042	4	2	14/20
M211044	4	4	14/20

Accessories:

- S181125 Replacement 2mm Teflon® Plug Only
- S181530 Replacement 4mm Teflon® Plug Only

MANIFOLD, NITROGEN/ARGON LINE, TEFLON®

With 14/20 outer joint at the center to fit a rubber septum for keeping syringes under an inert environment cutting down on the number used. Main tube is 22mm O.D. with left hose connections(10mm). Delivery ports have 8mm hose connections.

Item#	Number of Ports	Stopcock Bore (mm)	Joint
M531042	4	2	14/20

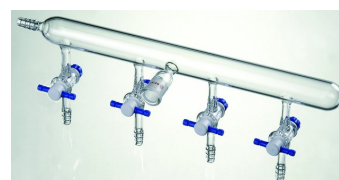
Accessories:

S181125 Replacement 2mm Teflon® Plug Only

MANIFOLD, NITROGEN/ARGON LINE, TEFLON®

With 14/20 outer joint at the center to fit a rubber septum for keeping syringes under an inert environment cutting down on the number used. Main tube is 22mm O.D. with right hose connections(10mm). Delivery ports have 8mm hose connections.

Item#	Number of Ports	Stopcock Bore (mm)	Joint
M541044	4	4	14/20

Accessories:

S181530 Replacement 4mm Teflon® Plug Only

MANIFOLD, DOUBLE, HOLLOW GLASS STOPCOCKS, SPHERICAL JOINT

With 35/20 ball joints and 4mm double oblique high vacuum hollow glass stopcocks precision ground with corresponding numbers on barrel and plugs. Lower vacuum chambers on stopcock are evacuated with a separate hole in the plug in order to hold the plug in the stopcock barrels.

Item#	Number of Ports	Overall Width (mm)	Glass Stopcock
M270004	4	365	hollow
M270005	5	450	hollow



MANIFOLD, DOUBLE, HOLLOW GLASS STOPCOCKS, RIGHT HAND SIDE

With high vacuum hollow glass stopcocks. The smaller O.D.(17mm) front tube is for inert gases and the larger O.D.(22mm) back tube is for vacuum, which has a 35/20 socket on the right hand side.



Item#	Number of Ports	Hose Connections (mm)	Glass Stopcock
M340004	4	10	Hollow

MANIFOLD, DOUBLE, HOLLOW GLASS STOPCOCKS, LEFT HAND SIDE

Similar to above manifold, but with the 35/20 socket on the left hand side



Item#	Number of Ports	Hose Connections (mm)	Glass Stopcock
M350004	4	10	Hollow

VACUUM TRAP, SPHERICAL JOINTS

With 35/20 spherical joints for added flexibility. Trap body is 50mm O.D. and 360 mm in length. Please order the three adapters and 35/20 SS pinch clamp separately.



Item#	Joints	Description
V175036	35/20	Vacuum Trap body
V175037	35/20	Top Adapter, 16mm O.D. outlet
V175038	35/20	Middle adapter/pump Adapter 16mm O.D. outlet
V175039	35/20	Bottom Adapter, 16mm O.D. outlet
CC3525	35/20	Clamps for 35/20 ball joints



VACUUM TRAP, 35/20 BALL JOINTS

For use with vacuum manifolds having 35/20 socket joints. Please order the pump adapter and socket clamp separately.



Item#	Joints	Outer Body O.D.(mm)	Length Outer Body Below Joint (mm)
V415045	45/50	50	250

Accessories:

- V175038 Pump Adapter
- CC3525 Clamps for 35/20 ball joint

MANIFOLD, DOUBLE, HIGH VACUUM VALVE AND 35/20 SPHERICAL JOINT

This manifold is designed to incorporate a 0-8mm high vacuum valve as the vacuum shut-off. The front tube is for inert gases (17mm O.D.), with a 10mm hose connection. The rear tube is for vacuum (22mm O.D.), with two 35/20 socket joints. Please order each component separately.

Item#	Description
M360004	Vacuum/gas manifold

Accessories:

- S540008 0-8mm high vacuum plug and control Knob (Viton® O-ring at tip)
- S450035 35# ball stopper
- CC3525 Clamps for 35/20 ball joint
- R108 Tip O-ring for 0-8mm high vacuum valve plug
- R110 Shaft O-ring for 0-8mm high vacuum valve plug



MANIFOLD, WITH #15 O-RING JOINTS

With 4mm double hollow high vacuum stopcocks. This four–port manifold is fitted with two 14/20 and 24/40 inner joints, and is 100mm center to center joints. #15 O-ring joint stopper (S480015) and #15 O-ring joint to serrated hose adapter have to be ordered separately. Viton® O-rings can be ordered using item #R116.



Item#	Description
M150004	Vacuum/gas manifold

Accessories:

CC2815	#15 O-ring joint stainless steel clamp
R116	#116 Viton® O-ring
S480015	#15 O-ring joint stopper
M131604	10mm O.D. serrated hose connection
M131605	16mm O.D. serrated hose connection

MANIFOLD, VACUUM, SINGLE, WITH #15 O-RING JOINTS

Four ports are spaced 100mm center to center, with 0-8mm high vacuum valves mounted on 45° angle to the operator for easy access. Overall width is 395mm. Standard taper components or stoppers are available below and have to be ordered separately.



Item#	Description
M311508	Vacuum manifold, single bank

Accessories:

S540008	0-8mm high vacuum plug and control knob, Viton® O-ring at tip
CC2815	#15 O-ring joint stainless steel clamp
R116	#116 Viton® O-ring
S480015	#15 O-ring joint stopper
M131604	10mm O.D. serrated hose connection
M131605	16mm O.D. serrated hose connection

MANIFOLD, DOUBLE BANKS, WITH #15 O-RING JOINTS

Forward facing 0-8mm high vacuum valves allow easy operation of manifold inside of a fume hood. Main parts are spaced 100mm center to center.

Adapter components or stoppers are available below and have to be ordered separately.

Item#	Description
M330804	Vacuum manifold, single bank

Accessories:

S540008	0-8mm high vacuum plug and control knob, Viton® O-ring at tip.
CC2815	#15 O-ring joint stainless steel clamp
R116	#116 Viton® O-ring
S480015	#15 O-ring joint stopper
M131604	10mm O.D. serrated hose connection
M131605	16mm O.D. serrated hose connection

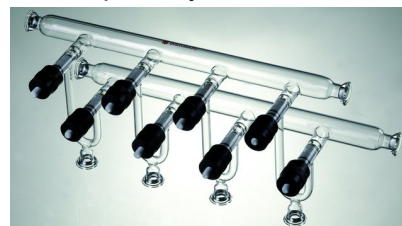
MANIFOLD, SOLVENT TRANSFER

Supplied with high vacuum valve with PTFE O-ring at tip and PTFE wiper to protect Viton® O-ring on shaft.

Item#	Joints	Overall Height*Width(mm)
M164380	24/40	140*380

Accessory:

S600004	0-4mm high vacuum plug and control knob (Teflon® O-ring at tip)
---------	---

STOPPER, WITH #15 O-RING JOINT

For use with manifolds having #15 O-ring joints. Supplied completely with One #116(R116) Viton® O-ring.

Item#	Description
S480015	#15 O-ring joint stopper

Accessories:

CC2815	#15 O-ring joint stainless steel clamp
R116	#116 Viton® O-ring





ADAPTER, #15 O-RING JOINT TO SERRATED HOSE CONNECTION

Item#	Description
M131604	10mm O.D. serrated hose connection
M131605	16mm O.D. serrated hose connection

Accessories:

- CC2815 #15 O-ring joint stainless steel clamp
- R116 #116 Viton® O-ring



ADAPTER, #15 O-RING JOINT TO INNER JOINT

Item#	Description
M131514	From #15 O-ring joint to 14/20 inner joint
M131519	From #15 O-ring joint to 19/22 inner joint
M131524	From #15 O-ring joint to 24/40 inner joint



DUAL VACUUM TRAP ASSEMBLY, WITH #15 O-RING JOINTS

For use with manifolds having #15 O-ring joints on banks (i.e, M150004 above) (E) and (G) are 0-12mm high vacuum valves as the shut off. (F) is a 0-4mm high vacuum valve having 9mm O.D. tubing towards the back of the drawing. (H) is a 0-8mm high vacuum valve. The pre-trap uses two 28/15 ball joints to add more flexibility to the assembly. The pre-trap uses a 57mm horseshoe clamp (CC0057) and two 57mm O-ring flanges to make quick connection. The #15 O-ring joint at the far-left is used to connect to manifold. The complete assembly comes with one brown Viton® O-ring (R116), two #15 O-ring clamps, and one 57mm horseshoe clamp.

Item#	Description
V115712	Dual trap assembly, complete

Accessories:

S540004	0-4mm high vacuum plug and control knob Viton® O-ring at tip
S540008	0-8mm high vacuum plug and control knob Viton® O-ring at tip
S540012	0-12mm high vacuum plug and control knob Viton® O-ring at tip
CC0057	57mm horseshoe clamp
CC2815	#15 O-ring joint stainless steel clamp
R116	#116 Viton® O-ring
R331	#331 Viton® O-ring



VACUUM TRAP, #15 O-RING JOINT

Supplied with two R116 Viton® O-rings.

Item#	Joint	O.D. outer Body (mm)	Outer Body Length Below Joint(mm)	O.D. Inner&Side Tube(mm)
V325045	45/50	50	250	18

Accessories:

CC2815	#15 O-ring joint stainless steel clamp
R116	#116 Viton® O-ring
A910001	Adapter with #15 O-ring joint, 19mm Outlet, 90° Angle
A910002	Adapter with #15 O-ring joint, 19mm Outlet, Straight





VACUUM TRAP, WITH #15 O-RING JOINTS

Two-piece design, with a 0-12mm high vacuum valve as the shut off. Connection is made via a 57mm O-ring flat flange(supplied, item CC0057) and a #331 Viton® O-ring (supplied, item R331). Outer body length below flange is 300mm. Smaller size tubing adapters are also available below. Please order #15 O-ring joint stainless Steel clamp (CC2815) separately.

Item#	Description
V381512	Vacuum trap with #15 O-ring joint

Accessories:

S540012	0-12mm high vacuum plug and control knob (with Viton® O-ring at tip)
CC0057	57mm horseshoe clamp
CC2815	#15 O-ring joint stainless steel clamp
R116	#116 Viton® O-ring
R331	#331 Viton® O-ring



VACUUM TRAP, WITH #15 O-RING JOINT

For use with above manifolds with #15 O-ring joint. The seal between upper and lower parts is made with a 57mm flat O-ring flange. Trap body is 57mm O.D. x 300mm in length. Complete trap assembly comes with CC0057 horseshoe clamp, One R331 Viton® O-ring and two R116 Viton® O-rings.

Item#	Description
V391557	Vacuum trap assembly, complete

Accessories:

CC0057	57mm horseshoe clamp
CC2815	#15 O-ring joint stainless steel clamp
R116	#116 Viton® O-ring
R331	#331 Viton® O-ring



ADAPTER, CONNECTING, INLET

Adapter has a #15 O-ring joint with a 0-4 mm high vacuum valve at a 90° angle connected to a piece of 10mm O.D. medium wall tubing, Overall height is 100mm. Each adapter is supplied completely with one #116 Viton® O-ring.

Item#	Description
A560001	Adapter, 90°, with #15 O-ring joint

Accessories:

S540004	High vacuum valve, with Viton® O-ring at tip
CC2815	#28 clamp for #15 O-ring joint
R116	#116 Viton® O-ring



STORAGE VESSEL, #15 O-RING JOINT

Storage vessel with a #15 O-ring joint on the sidearm and a high vacuum valve to control gas or liquid flow into the vessel. Supplied complete with one #116 Viton® O-ring.

Item#	Capacity (mL)	Valve Size	Approx. Height (mm)
S490050	50	0-4mm	190
S490100	100	0-8mm	235
S490350	350	0-8mm	240

Replacement Components:

S600004	0-4mm high vacuum plug and control knob(Teflon® O-ring at tip
S600008	0-8mm high vacuum plug and control knob(Teflon® O-ring at tip
CC2815	#15 O-ring joint stainless steel clamp
R116	#116 Viton® O-ring



STORAGE FLASK, #15 O-RING JOINT

Flask has a #15 O-ring joint on the sidearm and a high vacuum valve to control gas or liquid flow into the vessel. Supplied complete with one #116 Viton® O-ring.

Item#	Capacity (mL)	Valve Size	Approx. Height (mm)
S520500	500	0-8mm	190
S521000	1000	0-8mm	220

Replacement Components:

S600008	0-8mm high vacuum plug and control knob(Teflon® O-ring at tip
CC2815	#15 O-ring joint stainless steel clamp
R116	#116 Viton® O-ring



VACUUM TRAP

With joints for easy removal of condensate. Body length is measured below the joint. Connections at center tube is 10mm O.D. while side tube hose connection is 13mm.

Item#	Joint	O.D. Outer Body (mm)	Outer Body Length Below Joint(mm)	O.D. Inner& Side Tube (mm)
V103029	29/42	32	200	10
V103834	34/45	40	225	13
V104045	40/50	50	250	16
V105045	45/50	50	250	22
V105050	50/50	55	275	26
V105550	55/50	60	300	30

VACUUM TRAP

Trap is designed for large volume solvent removal by vacuum. With 45/50 joint. Connections at center tube is 12mm O.D. while side tube is 10mm.

Item#	Flask Capacity (mL)	Fits Dewar Flask Size	Approx. Overall Height×Width (mm)
V120500	500	1900 mL	310×130
V121000	1000	4300 mL	340×130

VACUUM TRAP

With joints for easy removal of condensate. Serrated hose connections for side tube have an O.D. of 13mm at the smallest serration and 16mm at the largest serration. Center tube hose connection is always 10mm for easy connection to manifold bank tubes which are also with 10mm hose connection.

Item#	Joint	O.D. Outer Body (mm)	Length, Outer Body Below Joint(mm)	O.D. Inner & Side Tube (mm)
V163024	24/40	30	200	10
V163229	29/42	32	200	10
V164034	34/45	40	225	16
V164050	40/50	45	250	16
V165045	45/50	50	250	22
V165050	50/50	55	275	26
V165550	55/50	60	300	30



NMR TUBE WASHER

With 24/40 inner joint and 10mm hose connection. For 5mm NMR tube only. The NMR tube is inserted into the tube cleaner with its plastic cap placed on the closed end to provide support and a vacuum seal. The washing solvent is sequentially added through the side tube while a vacuum is applied through the hose connection.

Item#	Joint
T100024	24/40



VACUUM TRAP, MICRO, DEWAR

Small scale dry ice, Dewar style trap. The dry-ice chamber is 40mm I.D. x 60mm in length. Choice PTFE stopcock for grease-free operation.

Item#	Lower Reservoir (mL)	Stopcock Type	Stopcock Bore (mm)
V200100G	100	Glass	2
V200100	100	Teflon®	2

Accessories:

- S181125 Replacement 2mm Teflon® Plug Only
- S461230 Replacement 2mm Glass Plug Only
- S691230 Replacement S.S. Retention for 2mm Glass Stopcock



VACUUM TRAP, DEWAR TYPE

Dry ice, Dewar style trap condenser designed for large volume solvent removal. Choice either glass stopcock for better vacuum or PTFE stopcock for grease-free operation. With 10mm hose connections.

Item#	Lower Reservoir (mL)	Stopcock Type	Stopcock Bore	Inner Chamber I.D. x Depth (mm)
V210250G	250	GLASS	4	59x230
V210250	250	Teflon®	4	59x230
V210500G	500	GLASS	4	75x275
V210500	500	Teflon®	4	75x275
V211000G	1000	GLASS	4	95x330
V211000	1000	Teflon®	4	95x330

Accessories:

- S181530 Replacement 4mm PTEF Plug Only
- S461740 Replacement 4mm Glass Plug Only
- S691740 Replacement S.S. Retention for 4mm Glass Stopcock



SOLVENT STILL HEAD, REPURIFICATION (GREASE-FREE)

Head only. Condenser and flasks not supplied. Access port has threaded 14/10 joint to accept a Teflon[®]-lined silicone septum with a compression cap (supplied). Threaded 14/10 also accept regular 14/20 glass or Teflon[®] stopper (not supplied).

Item#	Capacity(mL)	Joint
S134250	250	24/40
S134500	500	24/40

Accessories:

- S211444 Replacement 4mm Double Oblique PTEF Plug
- RC112 Replacement Nylon[®] compression cap
- R1420 Replacement Teflon[®]-lined silicone septum

SOLVENT STILL HEAD

Similar to above but with drip tip on the delivery port other than 14/20 inner joint. With 4mm straight bore stopcock in the upper portion for easy syringe needle access.



Item#	Capacity(mL)	Top Joint	Bottom joint
S234504	500	24/40	24/40
S234004	1000	24/40	24/40

Accessories:

- S181530 Replacement 4mm Teflon[®] Plug Only
- S201530 2mm Teflon[®] "T"-bore Stopcock Plug

SOLVENT STILL HEAD

Syringe port has 14/20 outer joint for a rubber septum and a 4mm Teflon[®] Stopcock. Solvent is drained through 2mm T-bore Teflon[®] stopcock. The drainage arm has a 14/20 inner joint.



Item#	Capacity(mL)	Top Joint	Bottom joint
S244504	500	24/40	24/40
S244004	1000	24/40	24/40
S244509	1000	24/40	29/42

Accessories:

- S181530 Replacement 4mm Teflon[®] Plug Only
- S201530 2mm Teflon[®] "T"-bore Stopcock Plug
- A741420 Evacuation/purging adapter, 14/20



SOLVENT STILL HEAD, HIGH VACUUM VALVES

For great solvent/chemical resistance, the two 0-4mm high vacuum valves have Teflon[®] covers over the two Viton[®] O-ring on the shaft and one integral Teflon[®] O-rings on the tip, without exposing any material other than Teflon[®] to any solvents. Syringe port has a 4mm Teflon[®] stopcock and a 14/20 outer joint. Delivery port has 14/20 inner joint.

Item#	Capacity(mL)	Joints
S264250	250	24/40

Accessories:

S181530	Replacement 4mm Teflon [®] Plug Only
S660004	0-4mm high vacuum metering plug and control valve (Teflon [®] protect O-rings)
A741420	Evacuation/purging adapter, 14/20



SOLVENT STILL, BUILT-IN CONDENSER

Grease-free design. Same as above with 14/10 threaded joint and Teflon[®]-lined septum for syringe access.

Item#	Capacity(mL)	Joint
S144125	125	24/40

Accessories:

S211444	Replacement 4mm Double Oblique PTFE Plug
RC112	Replacement Nylon [®] compression cap
R1420	Replacement Teflon [®] -lined silicone septum



DISTILLING HEAD, SOLVENT

Upper sampling port has a 4mm Teflon[®] stopcock with a 14/20 outer joint for use with septa. Lower drain is centered to allow total drainage of storage head.

Item#	Take-off Joint	Capacity (mL)	Double Oblique Stopcock Bore(mm)
S251250	14/20	250	2
S254250	24/40	250	2
S254500	24/40	500	2
S254000	24/40	1000	2

Accessories:

S181530 Replacement 4mm Teflon[®] Plug Only

S211944 Replacement 2mm Double Oblique PTEF Plug

SEPTUM, STOPPER, SLEEVE TYPE

Flanged type stopper with a hollow plug and sleeve extension that folds down over the neck of vessel, tubing, etc. The diaphragm can be punctured with a syringe needle, resealing after needle is withdrawn.

Item#	For use with
RS111420	14/20 outer joint
RS111922	19/22 outer joint
RS112440	24/40 outer joint
RS112942	29/42 outer joint

SYRINGE NEEDLE, STAINLESS STEEL

Long needle for solvent retrieval.

Item#	O.D.(mm)	Length (mm)
S380216	1.2	180
S380221	1.2	200
S380230	1.6	300



STOPPER, PENNY-HEAD, GLASS, HOLLOW

All sizes are with joints. Heavy wall design.

Item#	Joint
S401018	10/18
S401410	14/10
S401420	14/20
S401922	19/22
S402440	24/40
S402942	29/42
S403445	34/45
S404550	45/50



STOPPER, PENNY-HEAD, GLASS, SOLID

Item#	Joint
S291018	10/18
S291030	10/30
S291420	14/20
S291922	19/22
S292440	24/40
S292942	29/42



STOPPER, GLASS, FLASK LENGTH, PENNY-HEAD

Item#	Joint*
S280013	# 13
S280016	# 16
S280019	# 19
S280022	# 22
S280027	# 27
S280032	# 32
S280038	# 38



* All sizes are solid except #32 and #38 which are hollow.



STOPPER, CAP DESIGN

For apparatus having an inner opening.

Item#	Joint
S391420	14/20
S392440	24/40
S392942	29/42



STOPPER, WITH #15 O-RING JOINT

For use with manifolds having #15 O-ring joints. Supplied completely with One #116(R116) Viton® O-ring.

Item#	Description
S480015	#15 O-ring joint stopper

Accessories:

CC2815	#15 O-ring joint stainless steel clamp
R116	#116 Viton® O-ring



STOPPER, SPHERICAL, PENNY-HEAD

Hollow stopper for use with spherical socket joint.

Item#	Spherical Size
S450035	35

Accessory:

CC3525 Metal clamp for 35/20 or 35/25 spherical joint



STOPPER, TEFLON®

Teflon® handle stoppers for easy gripping.

Item#	Joint
S111420	14/20
S111922	19/22
S112425	24/25
S112440	24/40
S112942	29/42
S113445	34/45



STOPPER, TEFLON®, FLASK LENGTH

Item#	Joint Size
S120013	# 13
S120016	# 16
S120022	# 22
S120027	# 27
S120038	# 38



STOPPER, PTFE

Teflon® stopper has a Nylon® extraction nut permitting easy removal of the stopper from the glass outer joint.

Item#	Joint
S531018	10/18
S531420	14/20
S531922	19/22
S532440	24/40



TUBE, CONNECTING, Y-SHAPE

Item#	Tubing O.D.(mm)
T110800	8

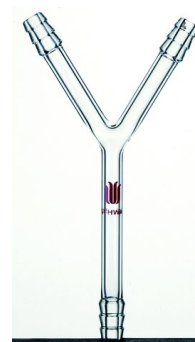

TUBE, CONNECTING, T-SHAPE

Item#	Tubing O.D.(mm)
T120800	8
T121000	10



CHECK VALVE

All glass, with ground seat for liquid seal.

Item#	Hose Connection(mm)
V180008	8



SLEEVE, TEFLON®, RIBBED WITH GRIPPING RING



Item#	Joint
T131420	14/20
T131922	19/22
T132440	24/40
T132942	29/42
T133445	34/45

SPRING, STAINLESS STEEL



Item#	Length of Coil(mm)
TH006	6.35
TH025	25.0
TH032	32.0



JOINT CLIP, STANDARD TAPER JOINT

Made of plastic.

Item#	Joint
CS001420	14/20
CS001922	19/22
CS002440	24/40
CS002942	29/42
CS003445	34/45
CS004550	45/50

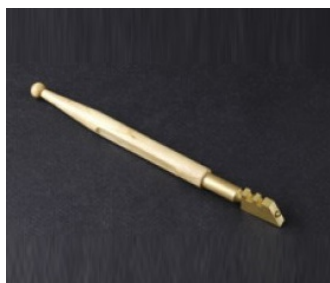

GLASS CUTTER, NATURAL DIAMOND

With rack on shank for breaking off single or double strength glass. Extra large natural diamond for durability.

Item#
DC18001



CLAMP, HORSESHOE STYLE

Made of aluminum with black epoxy coating.

Item#	For Flange Size
CC0057	57mm
CC0080	80mm



CLAMP, PINCH, STAINLESS STEEL, SPHERICAL

With a screw type locking nut.

Item#	Spherical Joint size/O-ring Joint Size
CC0012	12/5 ball joint, or #5 O-ring joint stainless steel clamp
CC0018	18/8 ball joint, or #9 O-ring joint stainless steel clamp
CC2815	28/15 ball joint, or #15 O-ring joint stainless steel clamp
CC3525	35/20,35/25 ball joint, or #25 O-ring joint stainless steel clamp
CC0050	50/30 ball joint, or #30 O-ring joint stainless steel clamp
CC0065	65/40 ball joint, or #40 O-ring joint stainless steel clamp
CC0075	75/50 ball joint, or #50 O-ring joint stainless steel clamp



O-RING, VITON®

For solvent and chemical compatibility.



Item#	Dimensions(mm)			Possible Application
	Size	I.D.	W	
R007	007	3.70	1.78	0-4mm high vacuum plug-tip or 5/5 threaded joint
R010	010	6.07	1.78	0-4mm high vacuum plug-shaft 7/10 threaded joint
R013	013	10.8	1.78	O-ring for 15mm stopper of internal thread
R014	014	12.30	1.78	14/10 threaded joints-Microscale
R107	107	5.23	2.62	Thermometer/inlet Adapters
R108	108	6.0	2.62	Top O-ring for 0-8mm high vacuum valve plug
R110	110	9.2	2.62	O-ring for 0-8mm high Vacuum valve plug/0-12mm high vacuum valve tip O-ring
R112	112	12.4	2.62	0-12mm high Vacuum valve shaft O-ring
R116	116	18.7	2.62	#15 O-ring joint
R121	121	26.6	2.62	O-ring for 25mm stopper of internal thread
R212	212	21.8	3.50	O-ring for 25mm bushing of internal thread
R221	221	21.8	3.50	Replacement #221 O-ring for Rodaviss joint
R223	223	40.9	3.50	Replacement #223 O-ring for Rodaviss joint
R225	225	4.72	3.50	O-ring for #50 internal thread
R226	226	50.4	3.50	O-ring for #40 O-ring joint
R229	229	59.9	3.50	O-ring for #50 O-ring joint
R331	331	56.5	5.33	57mm flat O-ring flange

FOUR FINGER CLAMP (SHANK)

Die-cast alloy, Ni/Cr plated finish, with cork lined interlocking jaws. Accepts articles up to 80mm in diameter.

Item#	Model
W170004	Chromed



THREE FINGER DOUBLE ADJUST-ABLE CLAMP (LARGE)

Double adjustable, PVC coated prongs, made of chrome-plated Zinc-alloy. Accept objects from 0 to 60mm.

Item#

W181103

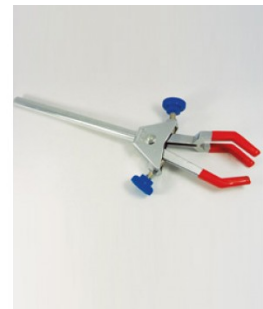

THREE FINGER DOUBLE ADJUST-ABLE CLAMP (SMALL)

Double adjustable, PVC coated prongs, made of chrome-plated Zinc-alloy. Accept objects from 0 to 30mm.

Item#

W192203



BOSSHEAD

Chrome plated finish, plastic headed screws. For rods up to 15mm diameter.

Item#

W200002



CLAMP THERMOMETER EXTENSION

Extension rod 10mm in diameter. Total length: 200mm.

Item#

W140200



CHAIN CLAMP

With chain and spring, for diameter from 80mm to 150mm.

Item#

W150150



SPATULAS

One end rounded and bend up, one end square.



Item#	Length(mm)
W160100	100
W160120	120
W160125	125
W160140	140
W160150	150
W160160	160
W160180	180
W160200	200
W160220	220
W160230	230

WEIGHT RING

Cast iron, PVC coated rings, for stabilizing Erlenmeyer flasks. Immersed in water.

Item#	Weight(kg)	I.D(mm)	For flasks
W110048	0.22	48	125-700mL
W110056	0.45	56	250-1000mL

CAP, COMPRESSION, WITH HOLE

Replacement caps with hole for use with thermometer/inlet adapters or microscale reaction vials.

Item#	Size (mm)	Possible Application	Material
RC005	8	Side port Hickman still head	Phenolic
RC009	13	Thermometer/inlet adapters	Nylon®
RC112	20	14/10 threaded joints-Microscale	Nylon®
RC2440	24	24/40 Rodaviss® Joint	Nylon®



SEPTUM, TEFLON®-LINED SILICONE RUBBER

Made of silicone rubber with PTFE face.

Item#	Size (mm)	Possible Application
R1408	8	Side port-Hickman still head
R1413	13	Thermometer/inlet adapters
R1420	20	14/10 threaded joints



REMOVABLE HOSE CONNECTION, FOR GL THREAD

With Caps listed below. Order each part separately.

Item#	Size	Style
R201402	14	Straight
R201801	18	Straight
RC14	14	#14 Nylon® Cap with 9.5mm hole
RC18	18	#18 Nylon® Cap with 11mm hole



PLURO-STOPPER

Used with Buchner and fritted glass funnels.

Item#	Size	Top/Bottom O.D. (mm)	Top/Bottom I.D. (mm)
P10	#1	21×11	17×7
	#3	37×22	31×16
	#5	58×38	50×30
	#6	69×45	60×36



SEPTUM, STOPPER, SLEEVE TYPE

Flanged type stopper with a hollow plug and sleeve extension that folds down over the neck of vessel, tubing, etc. The diaphragm can be punctured with a syringe needle, resealing after needle is withdrawn.



Item#	For use with
RS111420	14/20 outer joint
RS111922	19/22 outer joint
RS112440	24/40 outer joint
RS112942	29/42 outer joint

SEPTUM, STOPPER, SLEEVE TYPE THREADED

Stoppers are made from natural white rubber.

Item#	Joint
RS121420	14/20
RS121922	19/22
RS122440	24/40

SEPTUM, STOPPER, SLEEVE TYPE

Stoppers are made from natural white rubber for use with 5mm OD NMR Tubes.

Item#	NMR TUBE OD (mm)
RS1305	5



SYRINGE NEEDLE, STAINLESS STEEL

Long needle for solvent retrieval.

Item#	O.D.(mm)	Length (mm)
S380216	1.2	180
S380221	1.2	200
S380230	1.6	300



CANNULA, STAINLESS STEEL

For the transfer and handling of air sensitive materials.

Item#	Gauge	O.D.(mm)	I.D.(mm)	Needle Length(mm)
C701618	16	1.65	1.20	460
C701624	16	1.65	1.20	600
C701636	16	1.65	1.20	900
C701818	18	1.30	0.80	460
C701824	18	1.30	0.80	600
C701836	18	1.30	0.80	900
C702018	20	0.90	0.60	460
C702024	20	0.90	0.60	600
C702036	20	0.90	0.60	900
C702218	22	0.70	0.40	460
C702224	22	0.70	0.40	600
C702236	22	0.70	0.40	900



THERMOMETER, WITH 10/18 JOINT

With 10/18 joint, immersion length is measured from the bottom of 10/18 joint on thermometer to lower end of mercury bulb. Filling liquid is not Mercury.

Accuracy is $\pm 1^{\circ}\text{C}$.

Item#	Immersion(mm)	Range $^{\circ}\text{C}$
T162511	25	-20 to 110
T162525	25	-20 to 250
T162532	25	-20 to 320
T165011	50	-20 to 110
T165025	50	-20 to 250
T165032	50	-20 to 320
T167611	76	-20 to 110
T167625	76	-20 to 250
T167632	76	-20 to 320





STOPCOCK, TEFLON® STRAIGHT BORE

With 1:5 Teflon® plug and a threaded pressure nut. Stopcock barrels are polished to prevent PTFE plug from scratch.

Item#	Bore(mm)	Plug size	Stem O.D.(mm)
S101502	2	11/25	8
S101504	4	15.2/30	10
S101506	6	16/35	12

Accessories:

- S181125 Replacement 2mm Teflon® Plug Only
- S181530 Replacement 4mm Teflon® Plug Only
- S181635 Replacement 6mm Teflon® Plug Only



STOPCOCK REPLACEMENT PLUG, 1:5 TEFLON®, STRAIGHT BORE

This replacement kit is complete with one Teflon® plug (1:5 taper), one Teflon® washer, one O-ring.

Item#	Plug size	Bore(mm)	Stopcock Type
S181125	11/25	2	handle and nut
S181530	15.2/30	4	handle and nut
S181635	16/35	6	handle and nut



STOPCOCK REPLACEMENT PLUG, 1:5 TEFLON®, METERING VALVE

With a threaded Teflon® needle valve for the fine control of flow through the bore of the stopcock plug. This replacement kit is complete with all the components.

Item#	Plug Size	Bore(mm)
S191125	11/25	2
S191530	15.2/30	4



STOPCOCK, 1:5 TEFLON®, T-BORE

Stopcock with three stems sealed 90°apart. Teflon® Plug has a “T” shape bore to connect any two or all three stems.

Item# Plug Size Bore(mm) Stem O.D.(mm)

S161530	15.2/30	2	8
S161635	16/35	4	10

Accessories:

S201530	2mm Teflon® “T”-bore Stopcock Plug
S201635	4mm Teflon® “T”-bore Stopcock Plug

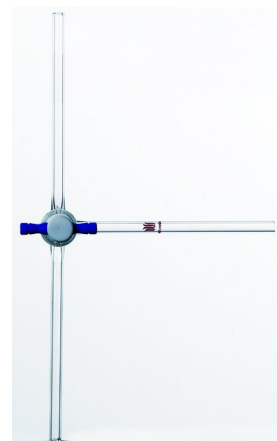

STOPCOCK REPLACEMENT PLUG, 1:5 TEFLON®, T-BORE

Item# Plug Size Bore(mm)

S201530	15.2/30	2
S201635	16/35	4



STOPCOCK, 1:5 TEFLON®, DOUBLE OBLIQUE BORE

With polished barrels.

Item# Plug Size Bore(mm) Stem O.D.(mm)

S171244	12.9/44	2	8
S171444	14.4/44	4	10

Accessories:

S211944	Replacement 2mm Double Oblique PTFE Plug
S211444	Replacement 4mm Double Oblique PTFE Plug





STOPCOCK REPLACEMENT PLUG, 1:5 TEFLON®, DOUBLE OBLIQUE BORE

Item#	Plug Size	Bore(mm)
S211944	12.9/44	2
S211444	14.4/44	4

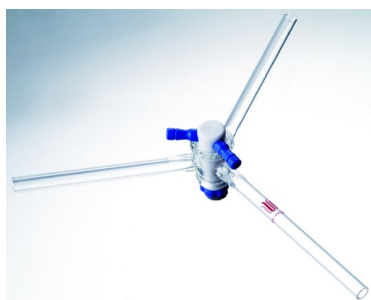

STOPCOCK, TEFLON®, 120° BORE

A 1:5 taper Teflon® stopcock with three sidearms sealed 120° apart. Plug has a bore to allow connection of any two arms at once.

Item#	Plug Size	Bore(mm)	Stem O.D.(mm)
-------	-----------	----------	---------------

S411530	15.2/30	2	8
---------	---------	---	---

Accessory:

S221530	2mm Teflon® 120° Bore Stopcock Plug		
---------	-------------------------------------	--	--



STOPCOCK, GLASS, HIGH VACUUM, STRAIGHT BORE

Plug is precision ground and hand-lapped with corresponding numbers one the barrel and plug, 1:10 taper. With constant pressure retention spring and clip.

Item#	Plug Size	Bore(mm)	Stem O.D.(mm)
-------	-----------	----------	---------------

S331230	12/30	2	8
S331740	17/40	4	10
S332044	20/44	6	12

Accessories:

S691230	Replacement S.S. Retention for 2mm Glass Stopcock		
S691740	Replacement S.S. Retention for 4mm Glass Stopcock		
S692044	Replacement S.S. Retention for 6mm Glass Stopcock		



STOPCOCK, STRAIGHT BORE, GLASS, INTERCHANGEABLE

Plugs and barrels are ground to be interchangeable, with 1:10 taper.

Item#	Bore(mm)	Stem O.D. (mm)	Supplied
S321230	2	8	Complete
S321740	4	10	Complete
S322044	6	12	Complete

Accessories:

- S461230 Replacement 2mm Glass Plug Only
- S461740 Replacement 4mm Glass Plug Only
- S462044 Replacement 6mm Glass Plug Only
- S691230 Replacement S.S. Retention for 2mm Glass Stopcock
- S691740 Replacement S.S. Retention for 4mm Glass Stopcock
- S692044 Replacement S.S. Retention for 6mm Glass Stopcock



STOPCOCK REPLACEMENT PLUG 1:10 GLASS

To be used with constant pressure retention kit (S69)

Item#	Bore(mm)	Plug size(mm)	Stopcock Type
S461230	2	12/30	Straight glass
S461740	4	17/40	Straight glass



STOPCOCK, GLASS, T-BORE

With solid glass plug. With constant pressure retention spring and clip.

Item#	Plug Size	Bore(mm)	Stem O.D.(mm)
S310217	12/30	2	8
S311740	17/40	4	10
S312044	20/44	6	12

Accessories:

- S510217 Replacement "T"-bore glass plug, 2mm hole
- S511740 4mm Glass "T"-bore Stopcock Plug
- S512044 Replacement T-bore glass plug, 6mm hole
- S691230 Replacement S.S. Retention for 2mm Glass Stopcock
- S691740 Replacement S.S. Retention for 4mm Glass stopcock
- S692044 Replacement S.S. Retention for 6mm Glass Stopcock





REPLACEMENT STAINLESS STEEL RETENTION KIT

Item#	Plug Size(mm)
S691230	12/30
S691740	17/40
S691750	17.35/50
S691656	16.2/56
S692044	20/44

STOPCOCK, GLASS, HIGH VACUUM, DOUBLE OBLIQUE BORE

With solid glass plug. Barrel and plug are precision ground, hand lapped with corresponding numbers on the barrel and plug. With constant pressure retention spring and clip.

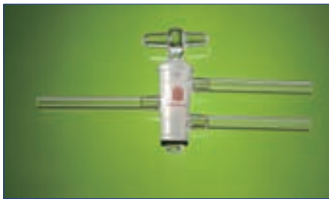

Item#	Plug Size	BoreSize(mm)	Sidearm O.D.(mm)
-------	-----------	--------------	------------------

S391656 16.2/56 4 10

Accessories:

S691656 Replacement S.S. Retention Kit for 16.2/56 Glass Stopcock

STOPCOCK, GLASS, HOLLOW PLUG, OBLIQUE, HIGH VACUUM

Precision ground with corresponding numbers on the barrel and plug. Lower vacuum chamber is evacuated via a separate 2mm hole in the plug which is not in the line of flow.



Item#	Plug Size	Bore(mm)	Stem O.D.(mm)
-------	-----------	----------	---------------

S341750 17.35/50 4 10

S342565 25/65 8 16



STOPCOCK, GLASS, HOLLOW PLUG, DOUBLE OBLIQUE, HIGH VACUUM

Precision ground with corresponding numbers on the barrel and plug. Lower vacuum chamber is evacuated via a separate 2mm hole in the plug which is not in the line of flow.

Item#	Plug Size	Bore(mm)	Stem O.D.(mm)
S351656	16.2/56	4	10



STOPCOCK, GLASS, HOLLOW PLUG, OFFSET, HIGH VACUUM

Precision ground with corresponding numbers on the barrel and plug. Lower vacuum chamber is evacuated via a separate 2mm hole in the plug which is not in the line of flow.

Item#	Plug Size	Bore(mm)	Stem O.D.(mm)
S701240	12.6/40	2	8
S701754	17.35/50	4	10
S701756	17.35/50	6	12



STOPCOCK, GLASS, HOLLOW PLUG, 90°, HIGH VACUUM

Precision ground with corresponding numbers on the barrel and plug. Lower vacuum chamber is evacuated via a separate 2mm hole in the plug which is not in the line of flow.

Item#	Plug Size	Bore(mm)	Stem O.D.(mm)
S711240	12.6/40	2	8
S711754	17.35/50	4	10
S711756	17.35/50	6	12



STOPCOCK, GLASS, HOLLOW PLUG, T-TYPE, HIGH VACUUM

Precision ground with corresponding numbers on the barrel and plug. Lower vacuum chamber is evacuated via a separate 2mm hole in the plug which is not in the line of flow.

Item#	Plug Size	Bore(mm)	Stem O.D.(mm)
S721240	12.6/40	2	8
S721754	17.35/50	4	10



PLUG, HIGH VACUUM VALVE, PTFE STEM, VITON® O-RING

Complete with control knob and PTFE stem having three O-rings.



Item#	Description
S540004	0-4mm high vacuum plug and control knob Viton® O-ring at tip
S540008	0-8mm high vacuum plug and control knob Viton® O-ring at tip
S540012	0-12mm high vacuum plug and control knob Viton® O-ring at tip

Accessories:

R7010 Viton® O-ring replacement Kit (Two 010 shaft O-rings and one 007 tip O-ring)for 0-4mm plug

R108110 Viton® O-ring replacement Kit (Two 010 shaft O-rings and one 007 tip O-ring)for 0-4mm plug

R110112 Viton® O-ring replacement Kit (Two 010 shaft O-rings and one 007 tip O-ring)for 0-4mm plug

VALVE, HIGH VACUUM, PTFE, O-RING, 90°

With two 9mm O.D. sidearms sealed to the barrel at a 90° angle to one another. The non-rotating PTFE plug has three O-rings, the tip O-ring making the primary seal on the precision formed tapered seat.



Item#	Description
S550004	0-4mm high vacuum valve,90° ,complete

Accessory:

S540004 0-4mm high vacuum plug and control knob Viton® O-ring at tip

VALVE, HIGH VACUUM, PTFE, O-RING, 180°

With two 9mm O.D. sidearms sealed to the barrel at a 90° angle to one another. The non-rotating PTFE shaft has three O-rings, the tip O-ring making the primary seal on the precision formed tapered seat . For replacement Viton® O-ring Kit, see R7010,or R108110.



Item#	Description
S560004	0-4mm high vacuum valve ,180°
S560008	0-8mm high vacuum valve ,180°

Accessories:

S540004 0-4mm high vacuum plug and control knob Viton® O-ring at tip

S540008 0-8mm high vacuum plug and control knob Viton® O-ring at tip



VALVE, HIGH VACUUM, PTFE, O-RING, THREE-WAY

With two 9mm O.D. sidearms sealed to the barrel at a 90° angle to one another. The non-rotating PTFE plug has three O-rings, the tip O-ring making the primary seal on the precision formed tapered seat.

Item#	Description
S580008	0-8mm high vacuum valve (3-way)
S580012	0-12mm high vacuum valve (3-way)

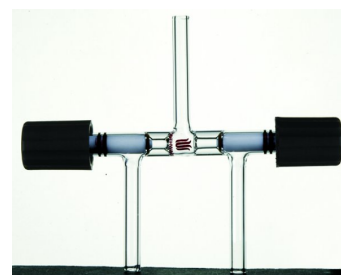

Accessories:

- S540008 0-8mm high vacuum plug and control knob Viton® O-ring at tip
- S540012 0-12mm high vacuum plug and control knob Viton® O-ring at tip

VALVE, HIGH VACUUM, PTFE, O-RING, T-TYPE

With two 9mm O.D. sidearms sealed to the barrel at a 90° angle to one another, The non-rotating PTFE shaft has three O-rings, the tip O-ring making the primary seal on the precision formed tapered seat. For replacement Viton® O-ring Kit, see R110112.

Item#	Description
S590012	0-12mm high vacuum valve(T-Type)

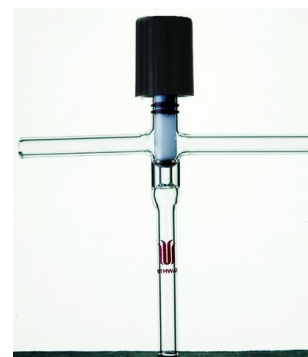

Accessory:

- S540012 0-12mm high vacuum plug and control knob Viton® O-ring at tip

PLUG, HIGH VACUUM, TEFLON® PROTECTED

Complete with control knob. Viton® O-rings on PTFE shaft are protected with precision Teflon® wipers. The plug has a machined-in integral PTFE tip O-ring to make the primary seal. This design provides for an excellent vacuum tight seal without exposing any material other than Teflon® to chemicals.

Item#	Description
S600004	0-4mm high vacuum plug and control knob(Teflon® O-ring at tip)
S600008	0-8mm high vacuum plug and control knob(Teflon® O-ring at tip)
S600012	0-12mm high vacuum plug and control knob(Teflon® O-ring at tip)



VALVE, HIGH VACUUM, TEFLON® PROTECTED, 180°

With two 9mm O.D. sidearms sealed to the barrel at a 180° angle to one another. Viton® O-ring on PTFE shaft are protected with precision Teflon® wipers. The plug has a machined-in integral PTFE tip O-ring to make the primary seal. This design provides for an excellent vacuum tight seal without exposing any material other than Teflon® to chemicals.



Item#	Description
S620004	0-4mm high vacuum valve(180°)
S620008	0-8mm high vacuum valve(180°)
S620012	0-12mm high vacuum valve(180°)

Accessories:

S600004	0-4mm high vacuum plug and control Knob(Teflon® covered O-ring)
S600008	0-8mm high vacuum plug and control Knob(Teflon® covered O-ring)
S600012	0-12mm high vacuum plug and control Knob(Teflon® covered O-ring)

VALVE, HIGH VACUUM, TEFLON® PROTECTED, LOW HOLD UP

With two 9mm O.D. sidearms bent to minimize hold up of liquids,. Viton® O-ring on PTFE shaft are protected with precision Teflon® wipers. The plug has a machined-in integral PTFE tip O-ring to make the primary seal. This design provides for an excellent vacuum tight seal without exposing any material other than Teflon® to chemicals

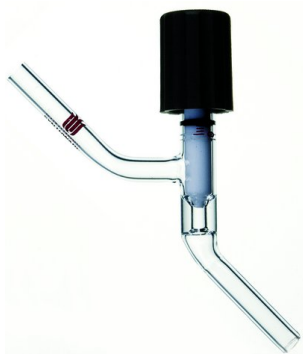

Item#	Description
S630004	0-4mm high vacuum valve(Low hold up)
S630008	0-8mm high vacuum valve(Low hold up)
S630012	0-12mm high vacuum valve(Low hold up)

Accessories:

S600004	0-4mm high vacuum plug and control Knob(Teflon® covered O-ring)
S600008	0-8mm high vacuum plug and control Knob(Teflon® covered O-ring)
S600012	0-12mm high vacuum plug and control Knob(Teflon® covered O-ring)



VALVE, HIGH VACUUM, TEFLON® PROTECTED, THREE-WAY

Viton® O-ring on PTFE shaft are protected with precision Teflon® wipers. The plug has a machined-in integral PTFE tip O-ring to make the primary seal. This design provides for an excellent vacuum tight seal without exposing any material other than Teflon® to chemicals.

Item#	Description
S640008	0-8mm high vacuum valve(3-way)

Accessory:

S600008	0-8mm high vacuum plug and control Knob(Teflon® covered O-ring)
---------	---

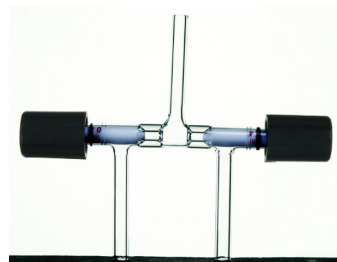

PLUG, HIGH VACUUM, TEFLON® PROTECTED, METERING

Complete with control knob. Viton® O-rings on PTEF shaft are protected with two precision Teflon® wipers (or as shown in the second picture, O-ring is inside shaft).The plug has a machined-in integral PTFE tip O-ring to make the primary seal. This design provide for an excellent vacuum tight seal without exposing any material other than Teflon® to chemicals.

Item#	Description
S660004	0-4mm high vacuum metering plug and control Valve (Teflon® half-covered O-ring)
S660008	0-8mm high vacuum metering plug and control Valve (Teflon® half-covered O-ring)
S660012	0-12mm high vacuum metering plug and control Valve (Teflon® half-covered O-ring)





VALVE, HIGH VACUUM, TEFLON® PROTECTED, 90° METERING

Viton® O-ring on PTFE shaft are protected with precision Teflon® wipers. The plug has a machined-in integral PTFE tip O-ring to make the primary seal. This design provides for an excellent vacuum tight seal without exposing any material other than Teflon® to chemicals. The glass portion has two sidearms sealed to the barrel at a 90° angle to one another.

Item#	Description
S670008	0-8mm high vacuum valve 90° (Teflon® covered O-rings)

Accessory:

S660008	0-8mm high vacuum metering plug and control Valve (Teflon® half-covered O-ring)
---------	---

VALVE, HIGH VACUUM, TEFLON® PROTECTED, LOW HOLD UP, METERING

Viton® O-ring on PTFE shaft are protected with precision Teflon® Wipers. The plug has a machined-in integral PTFE tip O-ring to make the primary seal. This design provides for an excellent vacuum tight seal without exposing any material other than Teflon® to chemicals. With two 9mm O.D. sidearm bent to minimize hold up of liquids.



Item#	Description
S680004	0-4mm high vacuum valve low hold up metering
S680008	0-8mm high vacuum valve low hold up metering
S680012	0-12mm high vacuum valve low hold up metering

Accessories:

S660004	0-4mm high vacuum metering plug and control valve(Teflon® covered O-rings)
S660008	0-8mm high vacuum metering plug and control Valve (Teflon® half-covered O-ring)
S660012	0-12mm high vacuum metering plug and control Valve (Teflon® half-covered O-ring)



SUBLIMATOR

A grease-free, two-piece sublimation apparatus consisting of an upper water cooled condenser and lower vessel to hold the material to be sublimed. The sublimate collects on the lower end of the condenser which has a flat bottom. Condenser is constructed using a grease-free, threaded valve. Connection of the condenser and lower vessel via an O-ring joint enables the two parts to be gently separated for maximum product recovery. Complete apparatus consists of the cold finger condenser, lower vessel, Viton® O-ring and stainless steel pinch clamp.

Item#	Description	Capacity (mL)	Joint Size	O-Ring Size	Clamp Size
S732510	10mL sublimation Complete	10	25	217	35
S734040	40mL sublimation Complete	40	40	226	65
S735060	60mL sublimation Complete	60	50	229	75

Accessories:

Application

- CC3525 #35 Stainless steel clamp or #25 O-ring joint
- CC0065 #65 Stainless steel clamp or #40 O-ring joint
- CC0075 #75 ball joint or #50 O-ring joint
- R217 #217 Viton® O-ring for #25 O-ring joint
- R226 #226 Viton® O-ring for #40 O-ring joint
- R229 #229 Viton® O-ring for #50 O-ring joint
- S600004 0-4mm high vacuum plug and control knob (Teflon® protected O-ring)



SUBLIMATION APPARATUS

Two-piece grease-free sublimer with a flat bottom to enable heating on a hot plate stirrer. Condenser has a large top opening for use with dry ice/acetone or liquid nitrogen. Connection between the flask and condenser is made with a flat O-ring joint permitting parts to be gently separated for maximum product recovery. The capacity listed is that below the bottom of the cold finger. Vacuum control is provided by a 0-8mm high vacuum valve. Complete apparatus consists of the condenser, flask, Viton[®] O-ring and horseshoe clamp.

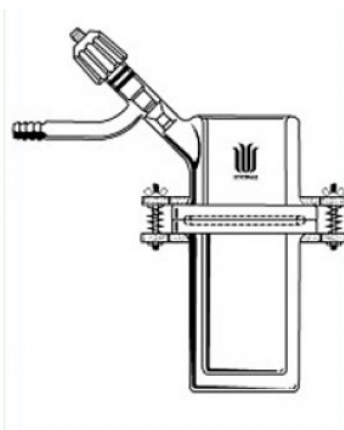

Item#	Description	Capacity (mL)	O-Ring Size	Flange Size(mm)
S740100	100mL Sublimer Complete	100	331	57
S740150	150mL Sublimer Complete	150	339	80

Replacement Components:

R331	#331 Viton [®] O-ring
R339	#339 Viton [®] O-ring
S600008	0-8mm PTFE Plug Only
CC0057	57mm Horseshoe Clamp
CC0080	80mm Flange Horseshoe Clamp

SUBLIMATOR, WITH 2MM GLASS STOPCOCK

Supplied with a special 25mL long-neck flask for small volume efficiency.

Item#	Stopcock	Joint
D232440G	2mm Glass	24/40

Accessories:

DF302425	Flask, round bottom, long neck, 25mL
S461230	Replacement 2mm Glass Plug Only
S691230	Replacement S.S. Retention for 2mm Glass stopcock



ADAPTER, GAS INLET/OUTLET

For microscale applications.

Item#	Joint	Hose Connection O.D.(mm)
A301410	14/10	8



ADAPTER, VACUUM, WITH 1:5 TEFLON® STOPCOCK

For microscale applications.

Item#	Joint	Stopcock Bore (mm)	Hose Connection O.D.(mm)
A381410	14/10	2	8



ADAPTER, INLET OR THERMOMETER

With a compression cap and Viton® O-ring to form a vacuum tight seal.

To use it as syringe port, simply replace the O-ring with Teflon®-lined septum. Cap accommodates 5.0-7.5mm O.D. thermometer.

Supplied with one Nylon® cap (RC009) and one Viton® O-ring (R107).

Item#	Joint
A771410	14/10



ADAPTER, THERMOMETER, WITH HOSE CONNECTION

With a compression cap and Viton® O-ring to form a vacuum tight seal.

To use it as syringe port, simply replace the O-ring with Teflon®-lined septum. Cap accommodates 5.0-7.5mm O.D. thermometer.

Supplied with one Nylon® cap (RC009) and one Viton® O-ring (R107).

Item#	Joint
A781410	14/10





ADAPTER, DISTILLATION, THREADED

Supplied with one holed compression cap and one Viton® O-ring. For replacement caps, see RC112; for Viton® O-ring, see R014.

Item#	Joint
A351410	14/10



ADAPTER, CLAISEN, THREADED

Supplied with two holed compression caps, two Viton® O-rings and two Teflon®-lined silicone rubber septa. For replacement caps, see RC112; for Viton® O-rings, see R014; for septa, see R1420.

Item#	Joint
A371410	14/10



ADAPTER, VACUUM TAKEOFF, THREADED

Supplied with one holed compression cap and one Viton® O-ring. For replacement caps, see RC112; for Viton® O-ring, see R014.

Item#	Joint
A621410	14/10



CONDENSER, AIR REFLUX, THREADED

Supplied with one holed compression cap one Viton® O-ring. For replacement caps, see RC112; for Viton® O-rings, see R014.

Item#	Joint	Effective Length (mm)
C221410	14/10	100



COLUMN, DISTILLING, VIGREUX

Supplied with one holed compression cap and one Viton® O-ring.
For replacement caps, see RC112; for Viton® O-rings, see R014.

Item#	Joint	Overall Length (mm)	Length Indented Section (mm)
C221410B	14/10	122	75



COLUMN, AIR REFLUX, 14/20 JOINT

Item#	Joints	Overall Length (mm)	Length between Joints(mm)
C221420	14/20	143	96



CONDENSER, REFLUX, JACKETED, THREADED

I.D. of inner tube is designed large enough to accept a thermometer. Supplied with one holed compression cap and one Viton® O-ring. For replacement caps, see RC112; for Viton® O-ring, see R014.

Item#	Joint	Jacket Length (mm)	Hose Connection O.D. (mm)
C201080	14/10	80	8



CONDENSER, COIL REFLUX

For low boiling solvents. Supplied with one holed compression cap and one Viton® O-ring. For replacement caps, see RC112; for Viton® O-rings, see R014; for septa, see R1420.

Item#	Joint
C321410	14/10





TUBE, DRYING, 90° BENT

Item#	Joint
A851410	14/10



HICKMAN STILL HEAD

Designed for microscale fractional distillation. Supplied with one compression cap, one Viton® O-ring and one Teflon® - faced silicone rubber septum. For replacement caps, see RC112; for Viton® O-rings, see R014; for septa, See R1420.

Item#	Joint
H101410	14/10



HICKMAN STILL HEAD, WITH SIDE PORT

Side port with cap and 8mm Teflon®-lined septum for syringe injection or retrieval. Designed for microscale fractional distillation. Supplied with one compression cap, one Viton® O-ring and one Teflon® -faced silicone rubber septum. For replacement caps, see RC005 and RC112; for Viton® O-rings, see R014; for septa, see R1408 and R1420.

Item#	Joint
H121410	14/10



DISTILLATION HEAD, HICKMAN-HINKLE, WITH SIDE PORT

This head has a threaded side port with septum and cap for easier syringe access to well contents. Supplied with one compression cap, one Viton® O-ring and one Teflon®-faced silicone rubber septum. For replacement caps, see RC005 and RC112; for Viton® O-rings, see R014; for septa, see R1408 and R1420.

Item#	Joint
H141410	14/10



TUBE, CRAIG RECRYSTALLIZATION

Complete with a glass outer tube and an inner plug.

Item#	Capacity Below Grind
T140002	2mL, Complete



VIAL, CONICAL REACTION, HEAVY WALL, GRADUATED

Supplied with one holed compression cap, one Viton® O-ring and one Teflon® -faced silicone rubber septum. For replacement caps, see RC112; For Viton® O-rings, see R014; for septa, see R1420.

Item#	Joint	Capacity(mL)
V130501	5/5*	0.1
V130701	7/10**	0.1
V130711	7/10**	1
V131003	14/10	3
V131005	14/10	5
V131008	14/10	8

*5/5 joint uses RC005 cap, R1408 septa and R006 O-ring.

**7/10 joint uses RC009 cap, R1413 septa and R107 O-ring.



CONICAL REACTION VIAL, 14/20, GRADUATED

Heavy wall vials have an internal conical bottom and flat bottom.

Item#	Joint	Capacity(mL)
V141003	14/20	3
V141005	14/20	5
V141008	14/20	8



FLASK, ROUND BOTTOM, THREADED

Supplied with one holed compression caps, one Viton[®] O-rings and one Teflon[®] - faced silicone rubber septum. For replacement caps, see RC112; for Viton[®] O-rings, see R014; for septa, see R1420.

Item#	Joint	Capacity (mL)
F301005	14/10	5
F301010	14/10	10
F301025	14/10	25

FLASK, PEAR SHAPE, THREADED

Supplied with one compression cap, one Viton[®] O-ring and one Teflon[®] -faced silicone rubber septum. For replacement caps, see RC112; for Viton[®] O-rings, see R014; for septa, see R1420.

Item#	Joint	Capacity(mL)
F321005	14/10	5
F321010	14/10	10
F321025	14/10	25

FLASK, ROUND BOTTOM, 3-NECK

Microscale, round bottom flask with three 14/10 outer ground joints externally threaded. For replacement caps, see RC112; for Viton[®] O-rings, see R014; for septa, see R1420.

Item#	Joint	Capacity(mL)
F591025	14/10	25
F591050	14/10	50

FUNNEL, FILTER

With 14/20 joints and a 20mm O.D. fritted disc.

Item#	Joints	Disc O.D. (mm)	Disc Porosity
F381420M	14/20	20	M



FILER FUNNEL, HIRSCH

With 10mm O.D. fritted disc of coarse porosity for all microscale application with 14/10 joints. The capacity above disc is approximately 7mL. The O.D. of plain stem is 7mm.

Item#	Porosity
F650010C	C



FUNNEL, MICRO

Item#	Description
F740027	27mm O.D. on top



STILL, SOLVENT REFLUX, MICROSCALE

Capacity of collection bulb is 15mL and has side syringe port with cap and septum for removal of solvent. With 2mm Teflon® stopcock and 14/20 Joints.

Item#	Description
S431015	Complete, w/o two-neck flask
F411125	Two neck flask, 14/20, 25ml
RC005	8mm Side port cap with hole



FLASK, ERLLENMEYER, THREADED

Supplied with one compression cap, one Viton® O-ring and one Teflon®-faced silicone rubber septum. For replacement caps, see RC112; for Viton® O-ring s, see R014; for septa, see R1420.

Item#	Joint	Capacity (mL)
F501005	14/10	5
F501010	14/10	10
F501025	14/10	25





FLASK, FILTERING, MICROSCALE

Top is tooled for a #2 neoprene filter adapter or #3 rubber stopper.

Item#	Capacity (mL)
F150025	25
F150050	50



HEAT TRANSFER BLOCK FOR MINI VIALS

Aluminum heat transfer block, used in place of a glass sand both in microscale experiments. It has holes to hold 3.0 and 5.0mL heavy wall reaction vials and four Craig crystallization tubes, one hold on the top for a standard thermometer.

Item#
H200001



HEATING TRANSFER BLOCK FOR ROUND BOTTOM FLASK

Aluminum heat transfer block, used in place of a glass sand both in microscale experiments. It will hold 5, 10 and 25mL round bottom flasks, one hold on the top for a standard thermometer.

Item#
H200003



SPINVANE FOR VIALS

Magnet is encased in PTFE and is used with conical shaped Mini-Vials.

Item#	Vial size (mL)
S470001	3.0 and 5.0

KIT, MICROSCALE, THREADED, 14 PIECES

Due to synthware®'s packaging flexibility, we can readily customize a kit that includes the specific components you require. Just give us a call and we'll give a quotation within 2 days.

This kit contains each of the following components:

Item #	Description	Quantity
K151410	Microscale Kit	1
A371410	Claisen adapter	1
A351410	Distillation adapter	1
A621410	Vacuum take-off adapter	1
C221410	Air reflux condenser	1
C201080	Jacket condenser	1
A851410	Drying tube	1
H101410	Hickman still head	1
T140002	Craig recrystallization tube, 2mL	1
V131003	Heavy wall conical vial, 3mL	1
V131005	Heavy wall conical vial, 5mL	1
F301010	Round bottom flask, 10mL	1
F301025	Round bottom flask, 25mL	1
F321010	Pear shape flask, 10mL	1
S470001	Spinvane, Teflon®	1
K130902	Polypropylene box with adjustable compartments.	1

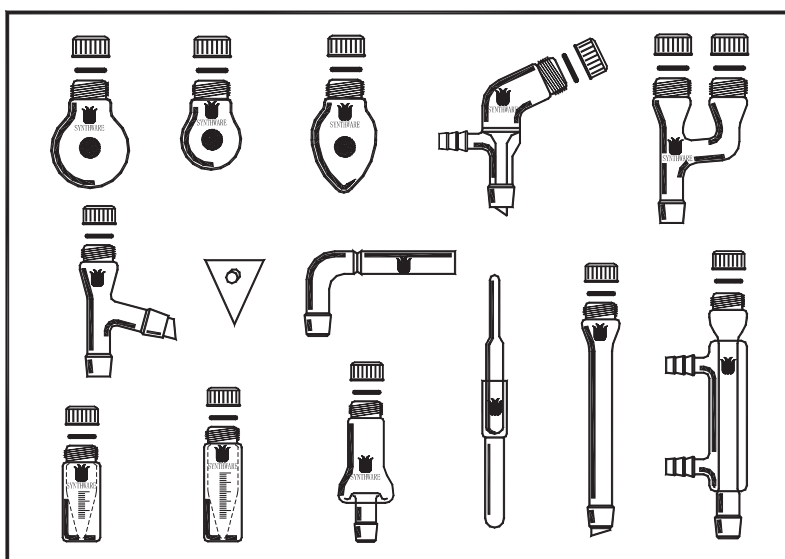

KIT, ORGANIC CHEMISTRY, 14/20

For use in college organic laboratory teaching courses. Considering most labs have equipped with drawers for every student, this kit can be ordered in paper carton, not with plastic box and foam insert in order to reduce cost.

Item#	Description	Quantity
K161420	Organic Chemistry Kit, Complete	1
A371420	Claisen adapter	1
A351420	Distillation adapter, 75° Angle	1
A621420	Vacuum takeoff adapter	1
A451420	Inlet/Thermometer Adapter	1
C150190	West Condenser, 190mm Jacket Length	1
C171200	Distillation Column, 200mm Jacket Length	1
F301425	Round Bottom Flask, 25mL	1
F301450	Round Bottom Flask, 50mL	1
F301100	Round Bottom Flask, 100mL	1
F301250	Round Bottom Flask, 250mL	1
F301500	Round Bottom Flask, 500mL	1
F451125	Separatory Funnel, 125mL	1
S401420	Glass Pennyhead Stopper	1
T151922	Bleed Tube	1

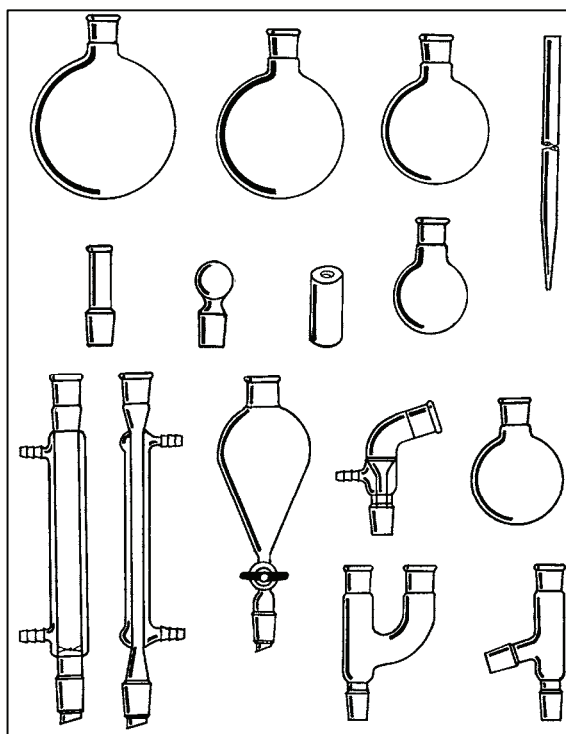

KIT, ORGANIC CHEMISTRY, 19/22

For use in college organic laboratory teaching courses. Considering most labs have equipped with drawers for every student, this kit can be ordered in paper carton, not with plastic box and foam insert in order to reduce cost.

Item#	Description	Quantity
K161922	Organic Chemistry Kit, Complete	1
A371922	Claisen adapter	1
A351922	Distillation adapter, 75° Angle	1
A621922	Vacuum take-off adapter	1
A451922	Inlet/Thermometer Adapter	1
C159190	West Condenser, 190mm Jacket Length	1
C179200	Distillation Column, 200mm Jacket Length	1
F301925	Round Bottom Flask, 25mL	1
F301950	Round Bottom Flask, 50mL	1
F309100	Round Bottom Flask, 100mL	1
F309250	Round Bottom Flask, 250mL	1
F309500	Round Bottom Flask, 500mL	1
F459125	Separatory Funnel, 125mL	1
S401922	Glass Pennyhead Stopper	1
T151922	Bleed Tube	1

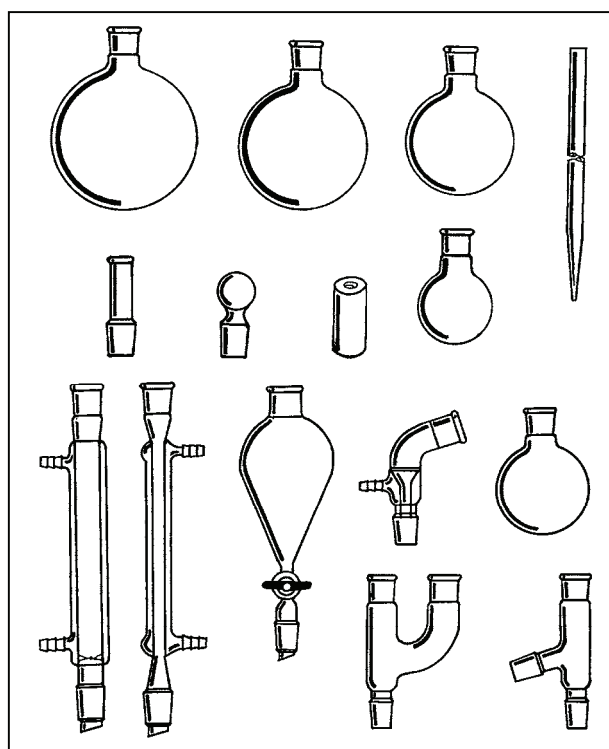

KIT, ORGANIC CHEMISTRY, 24/40

For use in college organic laboratory teaching courses. Considering most labs have equipped with drawers for every student, this kit can be ordered in paper carton, not with plastic box and foam insert in order to reduce cost.

Item#	Description	Quantity
K162440	Organic Chemistry Kit, Complete	1
A372440	Claisen adapter	1
A352440	Distillation adapter, 75° Angle	1
A622440	Vacuum take-off adapter	1
A452440	Inlet/Thermometer Adapter	1
C151190	West Condenser, 190mm Jacket Length	1
C174200	Distillation Column, 200mm Jacket Length	1
F302425	Round Bottom Flask, 25mL	1
F302450	Round Bottom Flask, 50mL	1
F304100	Round Bottom Flask, 100mL	1
F304250	Round Bottom Flask, 250mL	1
F304500	Round Bottom Flask, 500mL	1
F454125	Separatory Funnel, 125mL	1
S402440	Glass Pennyhead Stopper	1
T151922	Bleed Tube	1

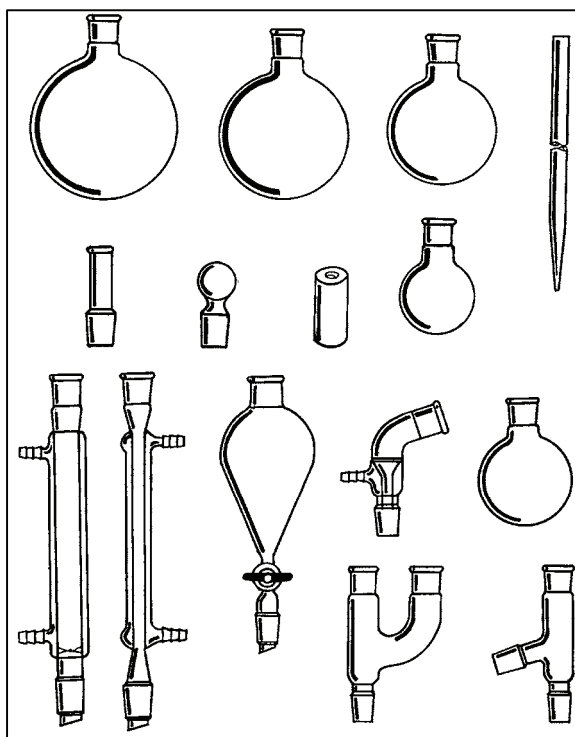



Item. No.	Page No.	Item. No.	Page No.	Item. No.	Page No.	Item. No.	Page No.
A							
A10	21	A72	9	C27	27	D37	49
A11	20	A73	9	C29	58	D38	49
A12	10	A74	11	C30	58	D44	56
A13	19	A74-G	11	C31	31	D45	56
A15	21	A75	6	C32	144	D50	55
A16	8	A76	9	C34	33	D53	50
A17	22	A77	142	C35	31	D54	50
A19	10	A78	142	C36	44	D68	51
A20	1	A79	1	C36-C	45	DC18	121
A23	13	A83	4	C37	39		
A25	1	A84	21	C38	42		
A26	12	A85	15,145,150	C38-C	43	E	
A27	12	A86	16	C39-C	40	E10	57
A28	13	A87	16	C41	46	E11-X/C	57
A29	3	A88	8	C43	46		
A30	4,47,142	A88-G	8	C50	33	F	
A31	8	A89	17	C52	29	F10	59
A32	5	A90	19	C53	31	F10-L-LA	59
A33	20	A92	4	C55	30	F11	35
A34	5	A95	4	C56	28	F12	61
A35	16,143,150-153	A96	12	C57	26	F14	62
A36	19	A97	17	C62	32	F15	149
A37	20,143, 150-153			C70	128	F16	76
A38	5,142	B		C90	34	F18	78
A39	15	B25	23	C91	34	F19	78
A40	22	B25-L	23	CC	122	F21	69
A41	11	B26	23	CS	121	F21L	69
A43	10	B30-X/C	24			F22	68
A45	2,151-153	B31-C	24	D		F23-C/M	43
A46	14	C		D10	52	F24	35
A49	22	C10	25	D11-G	56	F26-X/C/M	81
A50	15	C11	27	D12	48	F27-X/C/M	81
A52	2	C12	29	D13	55	F28-X/C/M	81
A53	3	C13	36	D14	54	F29	79
A54	18	C14	29	D15	47	F30	60,147,150-153
A55	53	C15	30,151-153	D16	51	F30L	60
A56	111	C16	25	D17	54	F31	63
A58	53	C17	26,151-153	D19	52	F31L	63
A59	53	C18	36,37	D20	53	F32	147,150
A60	14	C18-C	38	D21	54	F32L	64
A61	7	C19	36,41	D22	55	F33	62
A62	18,143,150-153	C19-C	41	D23-G	141	F34	64
A63	22	C20	33,144,150	D24	25	F35-C/M	82
A65	18	C21	26	D25	48	F36-C/M	79
A66	2	C22	143,144,150	D26	49	F37-C/M	88
A68	7	C22-B	144	D27	48	F38-M	147
A69	7	C23	27	D28	47	F39	78
A70	6	C24	57	D29	47	F41	65,148
A71	6	C25	32	D30	51	F41L	65
		C26	28	D35	52	F42	68
						F42L	68



Item. No.	Page No.	Item. No.	Page No.	Item. No.	Page No.	Item. No.	Page No.
F43	66	F98	58	P12-C/M	83	S60	136
F43L	66		G	P13-C/M	83	S62	137
F44	67	GL	84	P14-M	84	S63	137
F44-L	67		H	P15-C/M	85	S64	138
F45	89,151-153	H10	145,150	P16	87	S66	138
F45-A	89	H12	145	P17	87	S67	139
F46	73	H14	145		R	S68	139
F47	90	H20	149	R	84,123,126	S69	76,133
F47-A	90		K	RC	125,126,148	S70	134
F48	74	K13	150	RS	117,127	S71	134
F49	74	K15	150		S	S72	134
F49L	74	K16	151,152,153	S10	129	S73	140
F50	148		M	S11	119	S74	141
F52	61	M10	96	S12	120		T
F52L	61	M11	95	S13	115	T10	114
F53	76	M13	109	S14	116	T11	120
F54	75	M14	96	S16	130	T12	120
F54-L	75	M15	107	S17	130	T13	121
F55	82	M16	108	S18	129	T14	146,150
F56	75	M17	95	S19	129	T15	151-153
F58	71	M18	97	S20	130	T16	17,128
F59	147	M19	101	S21	131	T21	37
F60-X/C/M/F	80	M20	102	S23	115	T23	52
F61	92	M21	103	S24	115	TH	121
F62	92	M23	99	S25	117		V
F62-L-G	92,93	M24	100	S26	116	V10	113
F64	94	M25	99	S28	118	V11	110
F65-C	148	M26	100	S29	118	V12	113
F66	70	M27	104	S31	132	V13	146,150
F67	94	M28	100	S32	132	V14	146
F67-L	94	M29	101	S33	131	V15	86
F68	91	M30	101	S34	133	V16	113
F68-A-L-LA	91	M31	107	S35	134	V17	105
F70-C/M	82	M33	108	S38	117,128	V18	120
F71	69	M34	105	S39	119,133	V19	86
F71-L	69	M35	105	S40	118,151-153	V20	114
F72	70	M36	106	S41	131	V20-G	114
F74	148	M40	97	S43	148	V21	114
F75-C/M	78	M41	97	S45	119	V21-G	114
F76	73	M42	98	S46	132	V22	13
F77-C/M	77	M43	98	S47	149,150	V32	110
F78	91	M44	98	S48	108,119	V38	111
F79	63	M45	99	S49	112	V39	111
F80	80	M47	96	S51	8,132	V41	106
F89	77	M49	102	S52	112		W
F90	72	M50	102	S53	120	W11	125
F90-G	72	M52	103	S54	135	W14	124
F90-H	72	M53	104	S55	135	W15	124
F93	77	M54	104	S56	135	W16	125
F96	77		P	S58	136	W17	123
F97-C/M	88	P10	126	S59	136	W18	124
						W19	124
						W20	124



A

ADAPTER, ANTI-CLIMB 12
ADAPTER, ANTI-SPLASH 13
ADAPTER, ANTI-SPLASH, MODIFIED 14
ADAPTER, ANTI-SPLASH, WITH FRITTED DISC 13,14
ADAPTER, BENT, 75° 21
ADAPTER, BUSHING 1
ADAPTER, CLAISEN 20
ADAPTER,CONNECTING 10,20,21
ADAPTER, CLAISEN, THREADED 143
ADAPTER, CONNECTING, INLET 111
ADAPTER, DISTILLATION 19
ADAPTER, DISTILLATION, BENT, 105° 11
ADAPTER, DISTILLATION CONNECTING 16
ADAPTER, DISTILLATION CONNECTING, VIGREUX 19
ADAPTER, DISTILLATION HEAD 18
ADAPTER, DISTILLATION, THREADED 143
ADAPTER, DISTILLING, 75° 17
ADAPTER, DISTILLING, 105° 12
ADAPTER, DISTILLING, BENT, 105° 17
ADAPTER, DISTILLING TRAP 12
ADAPTER, DRYING TUBE, 75° 16
ADAPTER, DRYING TUBE, STRAIGHT 16
ADAPTER, DRYING TUBE, "U" SHAPED 15
ADAPTER, ENLARGING 1
ADAPTER, FLUSHING 7,9
ADAPTER, FLOW CONTROL, METERING STOPCOCK 9
ADAPTER, FLOW CONTROL, METERING STOPCOCK, 90° 9
ADAPTER, GAS INLET/OUTLET 142
ADAPTER, INLET 2,4,8
ADAPTER,INLET, LONGSTEM 18
ADAPTER, INLET OR THERMOMETER 2,142
ADAPTER, INLET, WITH HOSE CONNECTION 3,10
ADAPTER, KJELDAHL TRAP 22
ADAPTER, #15 O-RING JOINT TO SERRATED
HOSE CONNECTION 109
ADAPTER, #15 O-RING JOINT TO INNER JOINT 109
ADAPTER, OUTER JOINT, PTFE STOPCOCK 6
ADAPTER, OUTER JOINT, GLASS STOPCOCK 7
ADAPTER, REDUCING 1
ADAPTER, THERMOMETER 8
ADAPTER, THERMOMETER, WITH HOSE CONNECTION
..... 142
ADAPTER, TRANSFER VALVE 15

ADAPTER, TWIN CONNECTING HOSE 5
ADAPTER, U-SHAPE 22
ADAPTER, VACUUM 11
ADAPTER, VACUUM DISTILLING 22
ADAPTER, VACUUM FILTRATION 21
ADAPTER, VACUUM/GAS, BALL JOINT 3
ADAPTER, VACUUM, GLASS STOPCOCK, 90° 6
ADAPTER, VACUUM, GLASS STOPCOCK 7
ADAPTER, VACUUM/INERT GAS 8
ADAPTER, VACUUM/INERT GAS, 90° 4
ADAPTER, VACUUM OR ARGON 3
ADAPTER, VACUUM OR ARGON (NITROGEN) 4
ADAPTER, VACUUM, OUTER JOINT 5
ADAPTER, VACUUM, PTFE STOPCOCK 6
ADAPTER, VACUUM, WITH 1:5 TEFLON® STOPCOCK
..... 5,142
ADAPTER, VACUUM TAKE-OFF, SHORT STEM 18
ADAPTER, VACUUM TAKEOFF, THREADED 143
ADAPTER, VACUUM TRANSFER 10
ADAPTER, VACUUM, 90°, OUTER JOINT 4
ADAPTER, WITH MINERAL OIL BUBBLER 22
ADAPTER, WITH BALL SOCKET 2

B

BOSSHEAD 124
BOTTLE, GAS WASHING , FRITTED 24
BUBBLER 23
BUBBLER, MINERAL OIL 23

C

CANNULA, STAINLESS STEEL 128
CAP, COMPRESSION, WITH HOLE 125
CHECK VALVE 120
CHROMATOGRAPHY
COLUMN, HEAVY WALL DESIGN 37,38
COLUMN, SPHERICAL JOINTS 41
COLUMN, FRITTED DISC, SPHERICAL JOINTS 41
COLUMN, MODIFIED 43
FLOW CONTROL ADAPTER 36
FRITEED DISC 40,41,43,45
RESERVOIR 36
CLAMP
CHAIN 124
FOUR FINGER CLAMP (SHANK) 123
HORSESHOE STYLE 122
PINCH, STAINLESS STEEL, SPHERICAL 122



THERMOMETER EXTENSION.....	124
THREE FINGER DOUBLE ADJUSTABLE (LARGE/SMALL)	124
COLUMN	
AIR REFLUX, 14/20 JOINT.....	144
CHROMATOGRAPHY, TEFLON® STOPCOCK.....	44
CHROMATOGRAPHY, TEFLON® STOPCOCK, FRITTED DISC.....	45
CHROMATOGRAPHY WITH RESERVOIR.....	39,42
CHROMATOGRAPHY WITH RESERVOIR, FRITEED DISC.....	40,43
DISTILLING, VIGREUX	25,144
CONDENSER	
ALLIHN	32
ALLIHN, REMOVABLE HOSE CONNECTIONS	32
AIR REFLUX, THREADED.....	143
COILED	29
COIL REFLUX.....	144
COILED, REMOVABLE HOSE CONNECTIONS.....	29
COLD FINGER, WITH DRIP TIP	27
DEWAR, MICRO.....	33
DISTILLATION	26
DISTILLATION,VACUUM, JACKETED.....	25
DISTILLATION,REMOVABLE,HOSE CONNECTIONS..	26
FOR SOXHLET EXTRACTORS.....	57
FOR ROTARY EVAPORATORS.....	34
FOR ROTARY EVAPORATOR, UPRIGHT STYLE.....	34
FRIEDRICHS	27
FRIEDRICHS, WITH 24/40 JOINT.....	26
FRIDRICHS, REMOVABLE HOSE CONNECTIONS..	27
GRAHAM.....	29
LIEBIG.....	33
LIEBIG, REMOVABLE HOSE CONNECTIONS.....	33
REFLUX.....	28,31
REFLUX, REMOVABLE HOSE CONNECTIONS.....	28
REFLUX, JACKETED, THREADED.....	144
REFLUX, LARGE COOLING CAPACITY.....	31
REFLUX LARGE COOLING CAPACITY, REMOVABLE,HOSE,CONNECTION	31
WEST.....	30
WEST,REMOVABLE HOSE CONNECTIONS.....	30
CONCENTRATOR TUBE, GRADUATED.....	58
CONICAL REACTION VIAL, 14/20, GRADUATED.....	146
CRUCIBLE, GOOCH, LOW FORM	77

D

DESICCANT FLASK	55
DISTILLATION APPARATUS	
LARGE SCALE	55
MICROSCALE.....	47
MICROSCALE, VIGREUX	48
SHORT PATH,VACUUM JACKETED	48,49
SHORT PATH WITH 24/40 JOINT.....	49
VACUUM.....	52
DISTILLATION HEAD	
HICKMAN-HINKLE, WITH SIDE PORT.....	145
SOLVENT.....	117
SHORT PATH, FOR VOLATILE SOLVENTS.....	50
SHORT PATH, FOR VOLATILE DISTILLANTS.....	50
JACKETED, VIGREUX, MICRO	54
VIGREUX, JACKETED	54
VIGREUX, MICRO.....	54
MICROSCALE.....	56
DISTILLATION RECEIVER	
COW TYPE.....	49,51,52
DEAN STARK	56
GRADUATED,WITH HOOKS.....	52
SET.....	53
VERTICAL ORIENTATION.....	53
WITHOUT HOSE CONNECTION.....	48
DISTILLING BULB, KUGELROHR	47
DISTILLING COLUMN PACKING	25
DISH, CRYSTALLIZING, WITH SPOUTS.....	47
DRYING CHAMBER, ABDERHALDEN.....	55
DUAL VACUUM TRAP ASSEMBLY, WITH #15 O-RINGJOINTS.....	110

E

ERLENMEYER FLASK.....	70,148
EXTRACTOR, SOXHLET	57
EXTRACTION THIMBLE, GLASS.....	57

F

FOUR FINGER CLAMP (SHANK).....	123
FILTER	
FUNNEL, BUCHNER	80
FUNNEL, BUCHNER, INNER JOINT	79
FUNNEL, BUCHNER, INNER JOINT, PERFORATED PLATE.....	77
FUNNEL, PERFORATED PLATE.....	77



SYNTHWARE GLASS

FUNNEL, HIRSCH.....	148
TUBE, FRITTED DISC.....	82
FILTRATION APPARATUS	
47MM FRITTED, 40/35.....	59
47MM STAINLESS STEEL, 40/35.....	59
FLASK	
DEWAR, LOW FORM, HEMISPHERICAL.....	35
DEWAR, WIDE MOUTH, MENTAL HOUSING.....	35
EVAPORATION.....	63
ERLENMEYER.....	70
ERLENMEYER, THREADED.....	148
FLAT BOTTOM.....	61
FILTERING, MICROSCALE.....	149
FILTERING, WITH JOINT.....	70
HIGH VACUUM VALVE.....	74
KUDERNA-DANISH.....	58
MODIFIED SCHLENK TUBE.....	72
PEAR SHAPE, THREADED.....	147
PEAR SHAPED, SINGLE NECK.....	64
RECOVERY.....	63
REACTION, 2-NECK.....	76
REACTION, HIGH VACUUM VALVE.....	75
REACTION TUBE.....	77
REACTION TUBE, HIGH VACUUM VALVE.....	75
REACTION, WITH GLASS STOPCOCK.....	76
ROUND BOTTOM, 3-NECK.....	147
ROUND BOTTOM, 3-NECK BOTTOM OUTLET.....	68
ROUND BOTTOM, 4-NECK.....	69
ROUND BOTTOM, 4-NECK, ANGLED.....	68
ROUND BOTTOM 4-NECK, WITH THREADED SIDE ARM.....	69
ROUND BOTTOM, SINGLE NECK.....	60
ROUND BOTTOM, SPHERICAL JOINT.....	61
ROUND BOTTOM, THREADED.....	147
ROUND BOTTOM, THREADED INLET.....	62
ROUND BOTTOM WITH HOOKS.....	62
SOLVENT TRANSFER/STORAGE.....	74
STORAGE WITH OUTER JOINT.....	73
THREE NECK, VERTICAL.....	67
THREE NECK, ANGLED.....	66
TWO NECK, ANGLED.....	65
TWO NECK, PEAR SHAPED.....	64
FUNNEL	
ADDITION, HIGH VACUUM VALVE.....	82

ALPHABETICAL INDEX

FILTER.....	78,147
FILTER, FRITTED DISC.....	88
FILTER, BUCHNER, PERFORATED PLATE.....	80
POWDER.....	78
POWDER, FLATTENED SIDE.....	78
POWDER, 60° OFFSET.....	78
PRESSURE EQUALIZING.....	92
PRESSURE EQUALIZING, TEFLON®	
STOPCOCK.....	94
PRESSURE EQUALIZING, GLASS	
STOPCOCK.....	93
PRESSURE EQUALIZING, TEFLON®	
METERING STOPCOCK.....	92
PRESSURE EQUALIZING, HIGH VACUUM VALVE.....	94
SEPARATORY.....	89
SEPARATORY-SURE-GRIP.....	91
SEPARATORY, SQUIBB, GLASS STOPCOCK...	91
SEPARATORY, TEFLON® STOPCOCK.....	90
SOLVENT ADDITION.....	79
MICRO.....	148
FLOW CONTROL ADAPTER, CHROMATOGRAPHY	
RODAVISS®JOINT.....	46
G	
GAS DISPERSION TUBE, FRITTED.....	81
GAS DISPERSION TUBE, FRITTED,15°ANGLE.....	81
GAS DISPERSION TUBE, FRITTED, 90°ANGLE.....	81
GLASS CUTTER, NATURAL DIAMOND.....	121
GROUND JOINT, REDUCED DIAMETER, EXTENDED, DRIP TUBE.....	15
H	
HEAT TRANSFER BLOCK FOR MINI VIALS.....	149
HEATING TRANSFER BLOCK FOR ROUND BOTTOM FLASK.....	149
HICKMAN STILL HEAD.....	145
HICKMAN STILL HEAD, WITH SIDE PORT.....	145
I	
IMMERSION WELL PHOTOCHEMICAL QUARTZ WITHOUT JOINT.....	86
J	
JOINT CLIP, STANDARD TAPER JOINT.....	121
K	
KIT	



SYNTHWARE GLASS

MICROSCALE, THREADED, 14 PIECES.....	150
ORGANIC CHEMISTRY, 14/20.....	151
ORGANIC CHEMISTRY, 19/22.....	152
ORGANIC CHEMISTRY, 24/40.....	153
KUDERNA-DANISH FLASK.....	58

M

MANIFOLD

DOUBLE BANKLS, WITH #15 O-RING JOINTS.....	108
DOUBLE, HIGH VACUUM VAVLE AND 35/20	
SPHERICAL JOINT.....	106
SOLVENT TRANSFER.....	108
DOUBLE, HOLLOW GLASS STOPCOCKS,	
LEFT HAND SIDE.....	105
DOUBLE, HOLLOW GLASS STOPCOCKS,	
RIGHT HAND SIDE.....	105
DOUBLE, HOLLOW GLASS STOPCOCKS,	
SPHERICAL JOINT.....	104
HIGH VACUUM SOLID GLASS STOPCOCKS... 99-	101
HIGH VACUUM VALVE.....	102,103
NITROGEN/ARGON LINE, TEFLON®.....	103,104
TEFLON® STOPCOCKS.....	101-104
VACUUM/INERT GAS, ALL GLASS.....	97-99
VACUUM/INERT GAS, DOUBLE.....	95,96
VACUUM, SINGLE, WITH #15 O-RING JOINTS.....	107
WITH #15 O-RING JOINTS.....	107

N

NYLON® CAP WITH PROTECTED SEAL.....	84
NMR TUBE WASHER.....	114

O

O-RING, VITON®.....	123
---------------------	-----

P

PEPTIDE SYNTHESIS VESSEL

SOLID PHASE.....	83
SOLID PHASE T-BORE TEFLON® STOPCOCK.....	83
SOLID PHASE, T-BORE, VACUUM.....	84

PLUG

HIGH VACUUM, TEFLON® PROTECTED.....	136
HIGH VACUUM, TEFLON® PROTECTED,	
METERING.....	138
HIGH VACUUM VALVE, PTFE STEM,	
VITON® O-RING.....	135
PLURO-STOPPER.....	126
PRESSURE VESSEL, HEAVY WALL*.....	87

ALPHABETICAL INDEX

R

REACTION VESSEL, PHOTOCHEMICAL,	
INTERNAL THREAD.....	86
REMOVABLE HOSE CONNECTION, FOR GL THREAD ...	126
REPLACEMENT STAINLESS STEEL RETENTION KIT	76,133
RESERVOIR, CHROMATOGRAPHY, RODAVISS® JOINTS...	46

S

SEPARATORY FUNNELS.....	89-91
SEPTUM	
STOPPER, SLEEVE TYPE THREADED.....	127
STOPPER, SLEEVE TYPE.....	117,127
TEFLON®.....	84
TEFLON®-LINED SILICONE RUBBER.....	126
SLEEVE TEFLON®, RIBBED WITH GRIPPING RING.....	121
SNYDER DISTILLATION COLUMN.....	58
SOLVENT STILL	
BUILT-IN CONDENSER.....	116
HEAD.....	115
HEAD, REPURIFICATION (GREASE-FREE)....	115
HEAD HIGH VACUUM VALVES.....	116
SPRING, STAINLESS STEEL.....	121
SPATULAS.....	125
SPINVANE FOR VIALS.....	149
STILL, SOLVENT REFLUX, MICROSCALE.....	148
STOPCOCK	
GLASS, HIGH VACUUM, DOUBLE OBLIQUE	
BORE.....	133
GLASS, HIGH VACUUM, STRAIGHT BORE... 131	
GLASS, HOLLOW PLUG, DOUBLE OBLIQUE,	
HIGH VACUUM.....	134
GLASS, HOLLOW PLUG, 90°, HIGH VACUUM... 134	
GLASS, HOLLOW PLUG, OBLIQUE, HIGH	
VACUUM.....	133
GLASS, HOLLOW PLUG, OFFSET, HIGH	
VACUUM.....	134
GLASS, HOLLOW PLUG, T-TYPE, HIGH	
VACUUM.....	134
GLASS, T-BORE.....	132
GLASS, STRAIGHT BORE,	
INTERCHANGEABLE.....	132
GLASS, HOLLOW PLUG, DOUBLE OBLIQUE... 133	
TEFLON® STRAIGHT BORE.....	129
1:5 TEFLON®, DOUBLE OBLIQUE BORE....	130



SYNTHWARE GLASS

1:5 TEFLON®, T-BORE.....	130
TEFLON®, 120°BORE.....	131
STOPCOCK REPLACEMENT PLUG	
1:5 TEFLON®, DOUBLE OBLIQUE BORE....	130
1:5 TEFLON®, T-BORE.....	130
1:5 TEFLON®, METERING VALVE.....	129
TEFLON® STRAIGHT BORE.....	129
1:10 GLASS.....	132
STOPPER	
CAP DESIGN.....	119
GLASS, FLASK LENGTH, PENNY-HEAD.....	118
PTFE.....	120
PENNY-HEAD, GLASS, HOLLOW.....	118
PENNY-HEAD, GLASS, SOLID.....	118
SPHERICAL, PENNY-HEAD.....	119
TEFLON®.....	119
TEFLON®, FLASK LENGTH.....	120
WITH #15 O-RING JOINT.....	108,119
STORAGE FLASK, #15 O-RING JOINT.....	112
STORAGE VESSEL, #15 O-RING JOINT.....	112
SUBLIMATOR.....	140
SUBLIMATION APPARATUS.....	141
SUBLIMATOR, WITH 2MM GLASS STOPCOCK.....	141
SYRINGE NEEDLE, STAINLESS STEEL.....	117,128

T

THERMOMETER, WITH 10/18 JOINT.....	17,128
TLC DEVELOPING TANKS – CYLINDRICAL.....	37
THREE FINGER DOUBLE ADJUSTABLE	
CLAMP (LARGE).....	124
THREE FINGER DOUBLE ADJUSTABLE	
CLAMP (SMALL).....	124
TUBE	
CONNECTING, Y-SHAPE.....	120
CRAIG RECRYSTALLIZATION.....	146
DRYING, 90°BENT.....	145
STORAGE, HIGH VACUUM VALVE.....	71
STORAGE WITH OUTER JOINT.....	73

V

VACUUM TRAP.....	113
35/20 BALL JOINTS.....	106
DEWAR TYPE.....	114
MICRO, DEWAR.....	114
#15 O-RING JOINT.....	110
SPHERICAL JOINTS.....	105

ALPHABETICAL INDEX

WITH #15 O-RING JOINT.....	111
WITH #15 O-RING JOINTS.....	111
VALVE,HIGH VACUUM	
PTFE, O-RING, T-TYPE.....	136
PTFE, O-RING, THREE-WAY.....	136
PTFE, O-RING, 90°.....	135
PTFE, O-RING, 180°.....	135
TEFLON® PROTECTED,180°.....	137
TEFLON® PROTECTED, LOW HOLD UP.....	137
TEFLON® PROTECTED, THREE-WAY.....	138
TEFLON® PROTECTED, 90°METERING.....	139
TEFLON® PROTECTED, LOW HOLD UP, METERING.....	139
VAPOR DUCT, ROTARY EVAPORATOR.....	142
VESSEL, WITH LOWER JOINT AND T-BORE PTFE PLUG..	85
VIAL, CONICAL REACTION, HEAVY WALL, GRADUATED.....	146
W	
WEIGHT RING.....	125